

The interaction between LS-OPT, ANSA and META

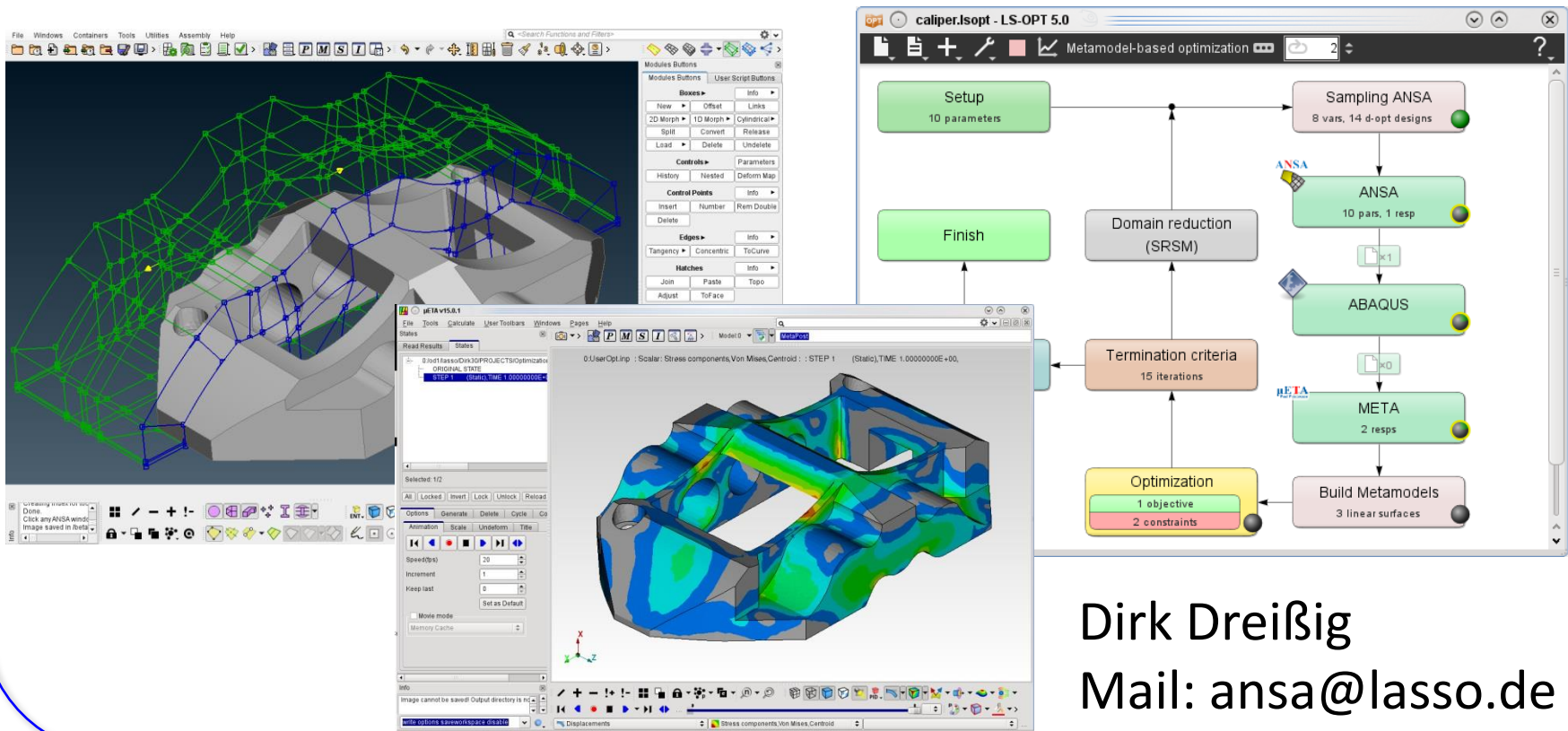

Dirk Dreißig
Mail: ansa@lasso.de

For what **ANSA & META**?

For what **ANSA & META**?

- **ANSA** for model-change according to design variables (everything besides LS-DYNA with *PARAMETER)

For what **ANSA** & **META**?

- **ANSA** for model-change according to design variables (everything besides LS-DYNA with *PARAMETER)
- **META** for results extraction of arbitrary (supported) solvers (besides LS-DYNA)

For what **ANSA** & **META**?

- **ANSA** for model-change according to design variables (everything besides LS-DYNA with *PARAMETER)
- **META** for results extraction of arbitrary (supported) solvers (besides LS-DYNA)
- **Setup phase**
 - design variables defined in **ANSA** → transfer to **LS-OPT**
 - histories and responses defined in **META** → transfer to **LS-OPT**

For what **ANSA & META**?

- **ANSA** for model-change according to design variables (everything besides LS-DYNA with *PARAMETER)
- **META** for results extraction of arbitrary (supported) solvers (besides LS-DYNA)
- **Setup phase**
 - design variables defined in **ANSA** → transfer to **LS-OPT**
 - histories and responses defined in **META** → transfer to **LS-OPT**
- **Optimization (Run) phase**
 - design variables controlled by **LS-OPT** → transfer to **ANSA**
 - histories and responses calculated by **META** → transfer to **LS-OPT**

Optimization Setup

ANSA → Solver → META → LS-OPT

Optimization Setup

ANSA → Solver → META → LS-OPT

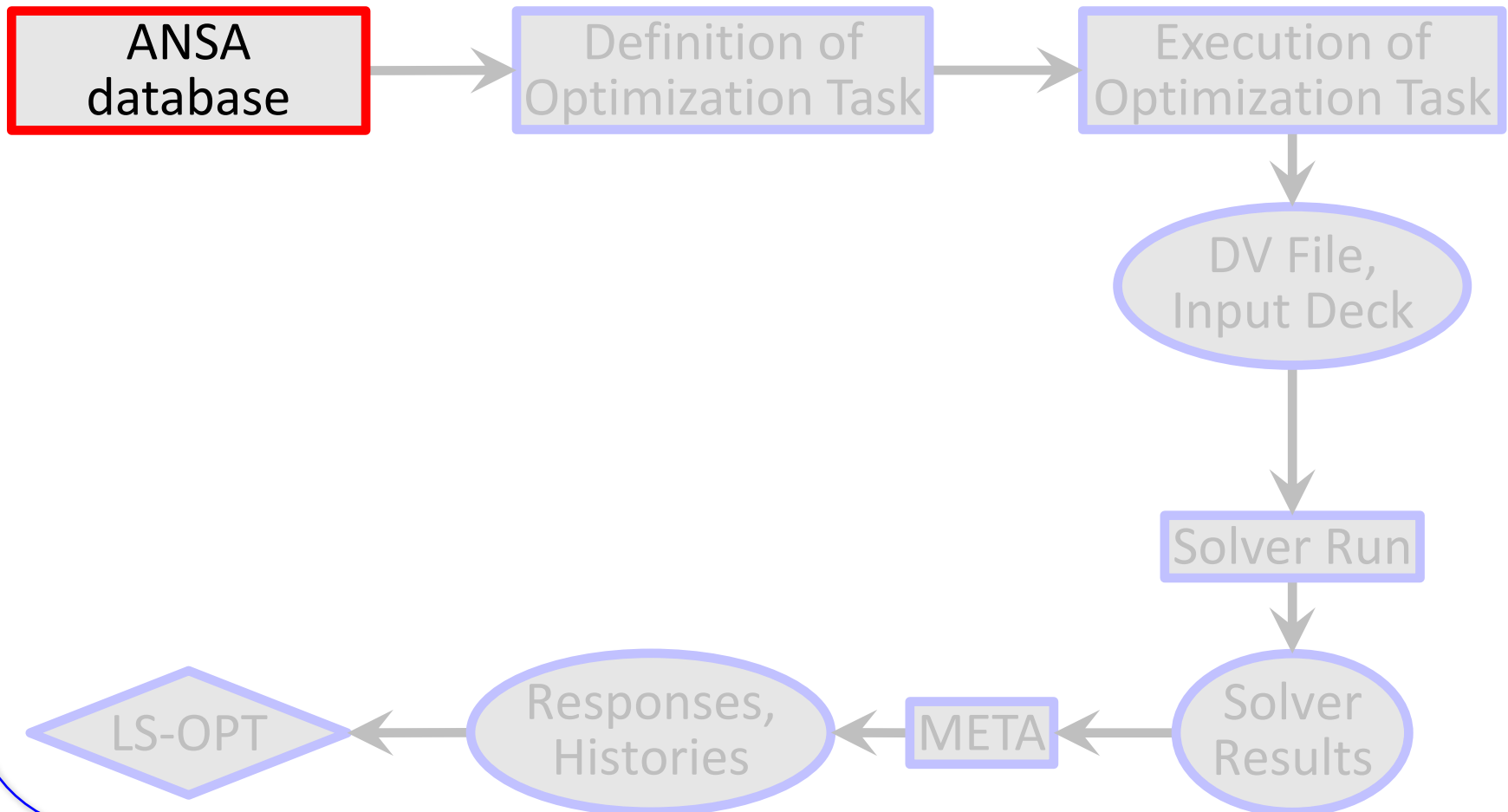

Optimization Setup

ANSA → Solver → META → LS-OPT

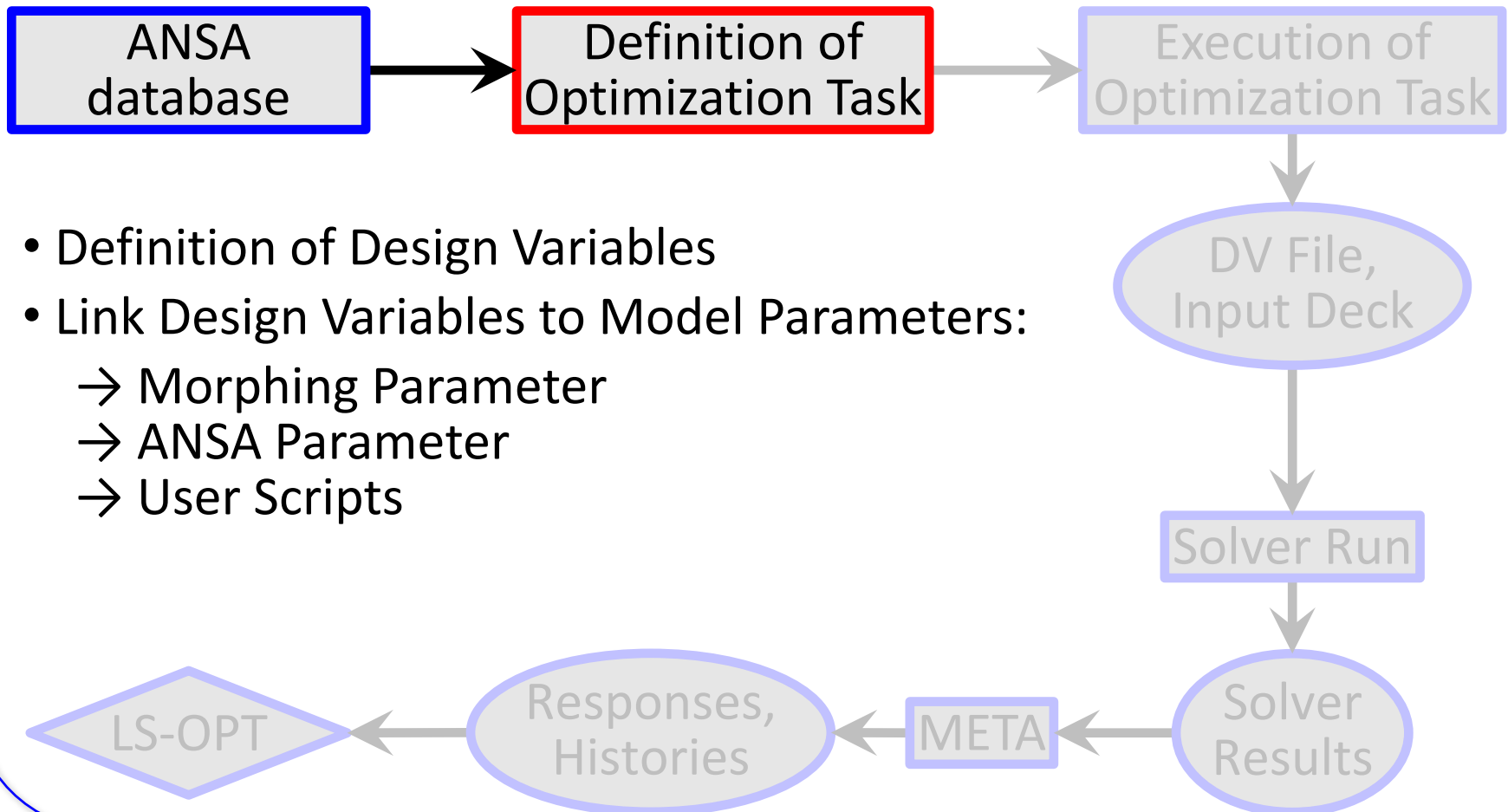

Optimization Setup

ANSA → Solver → META → LS-OPT

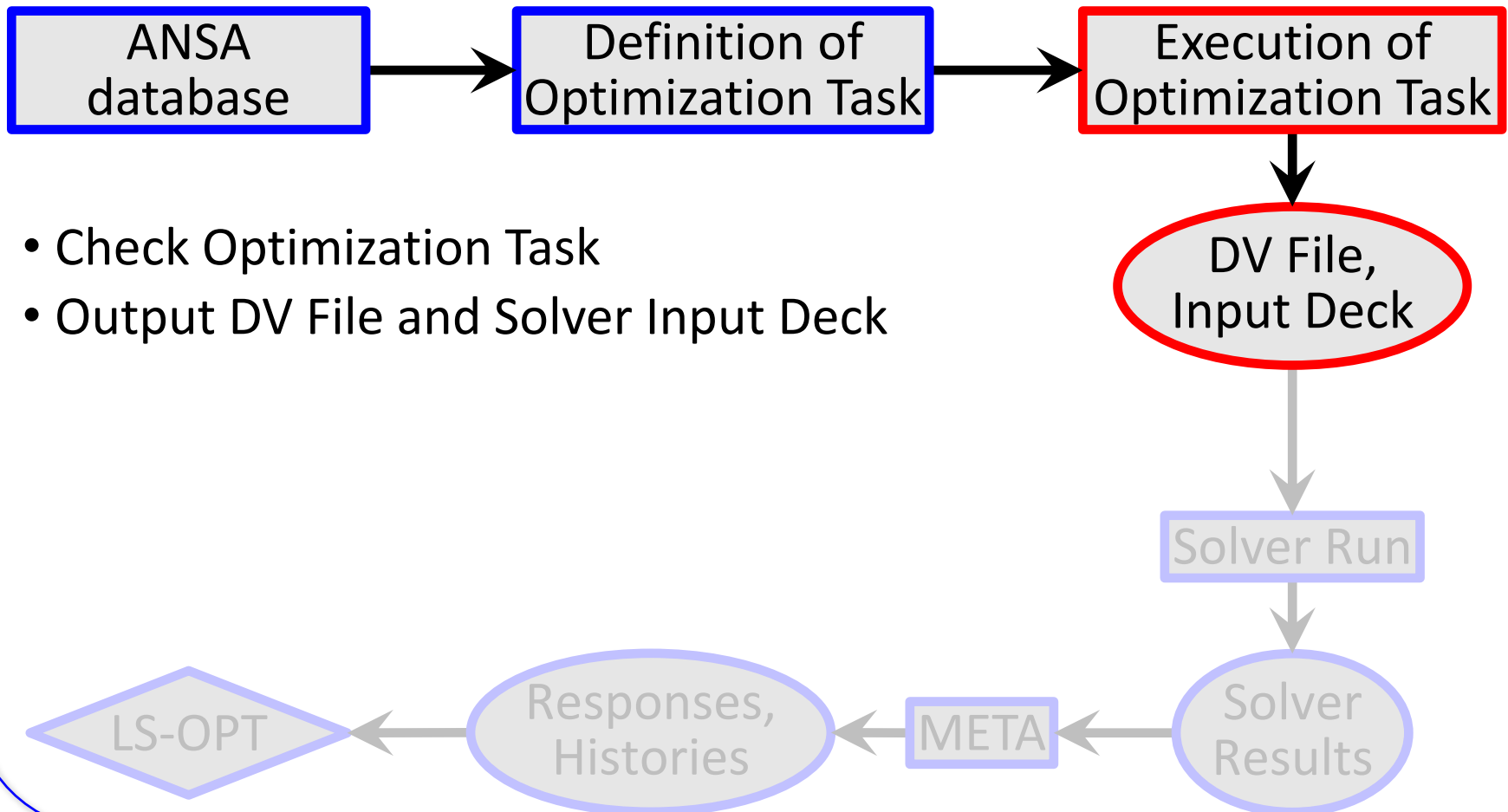

Optimization Setup

ANSA → **Solver** → META → LS-OPT

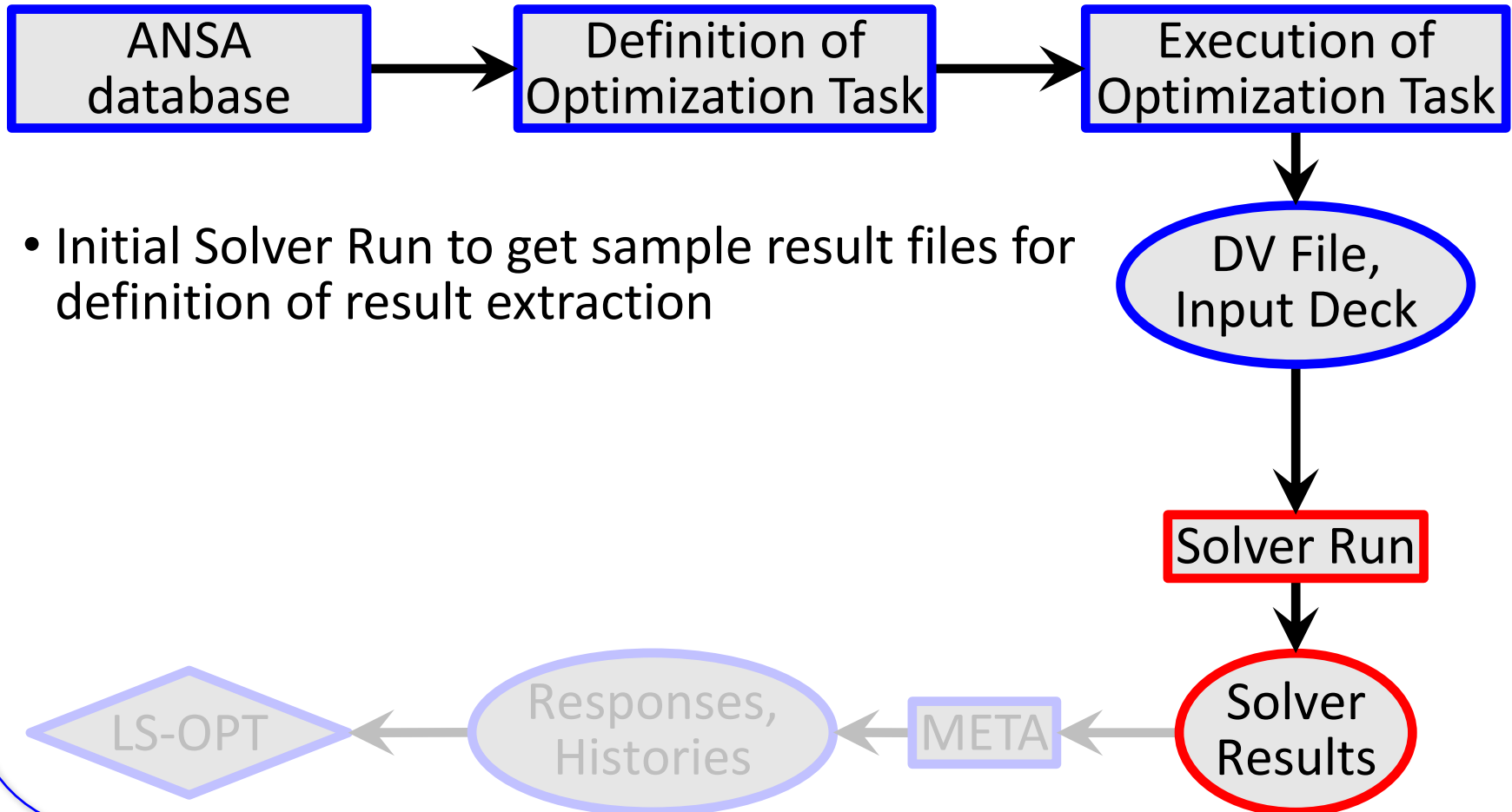

Optimization Setup

ANSA → Solver → **META** → LS-OPT

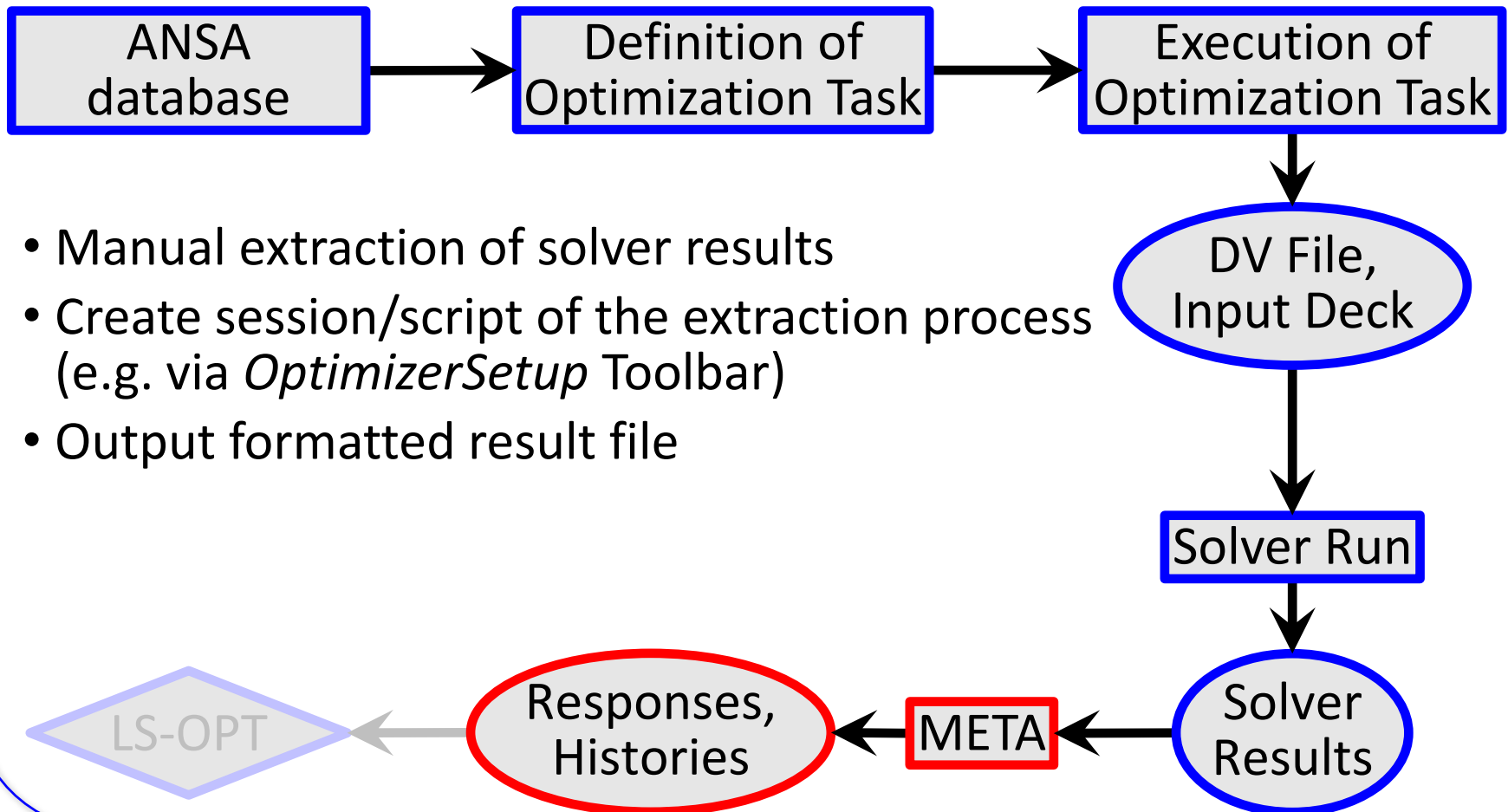

Optimization Setup

ANSA → Solver → META → **LS-OPT**

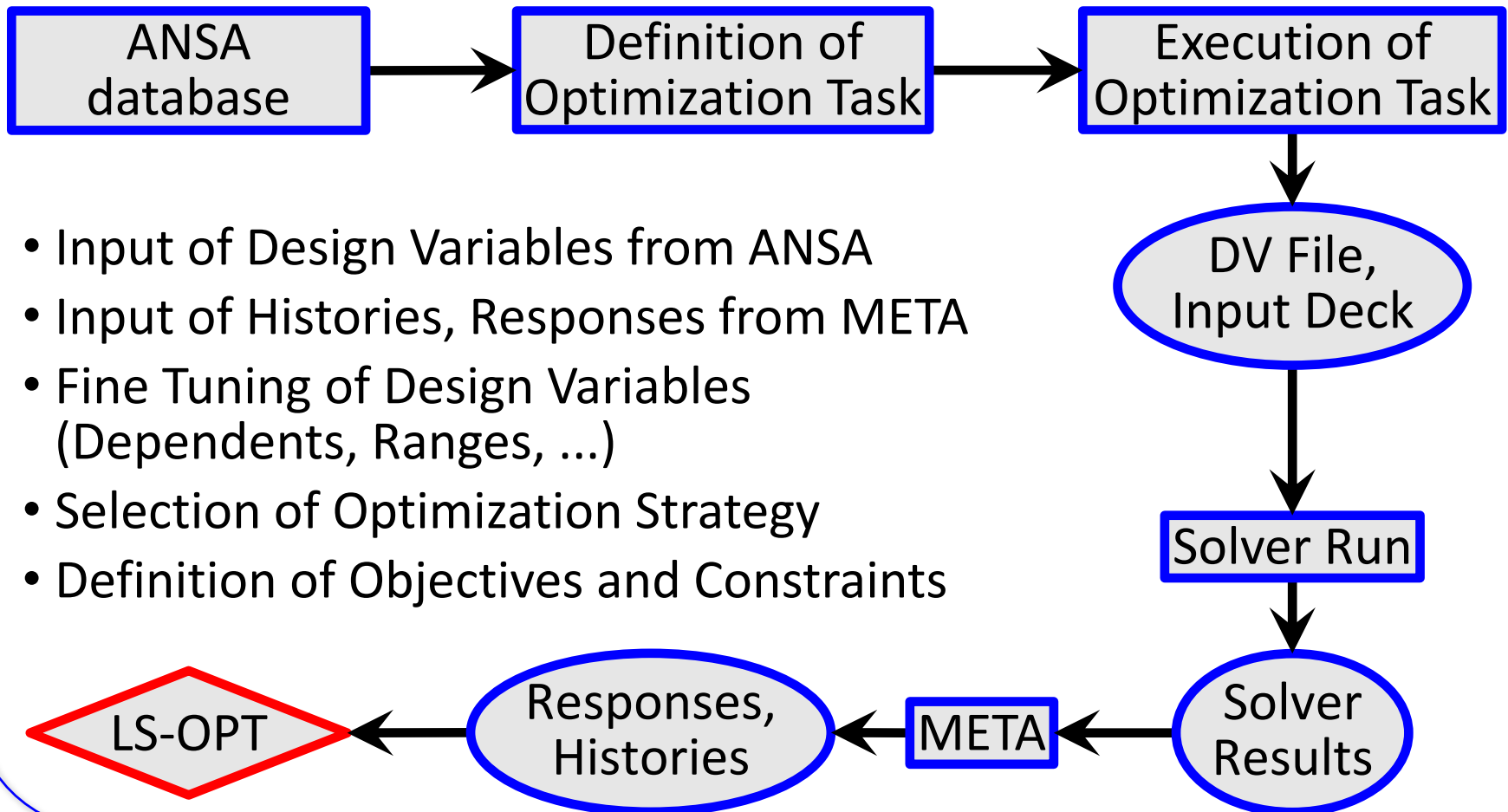

ANSA – Optimization Task

3 main task items

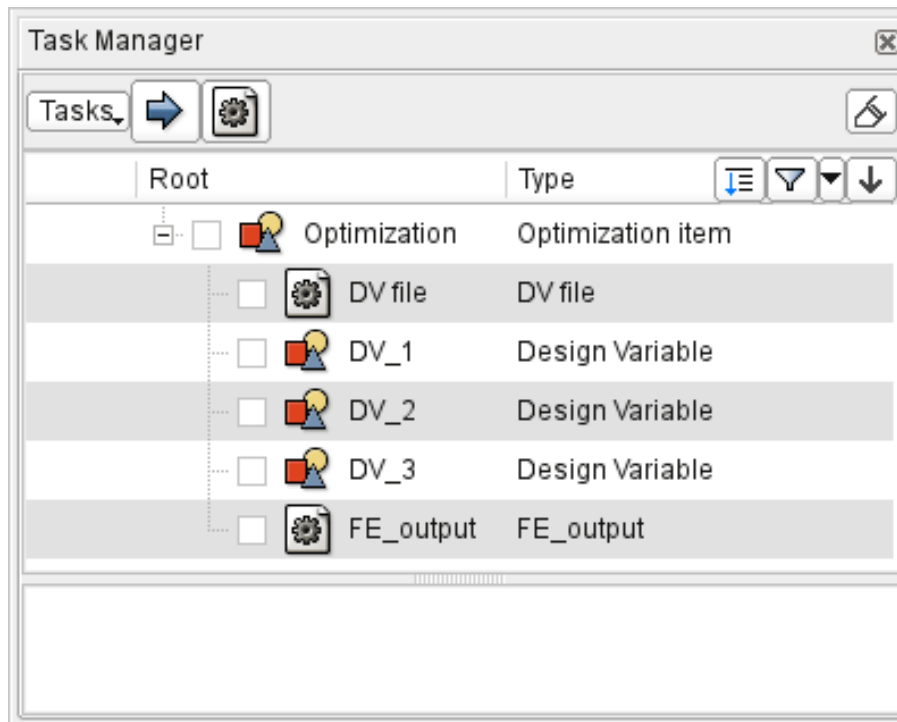

ANSA – Optimization Task

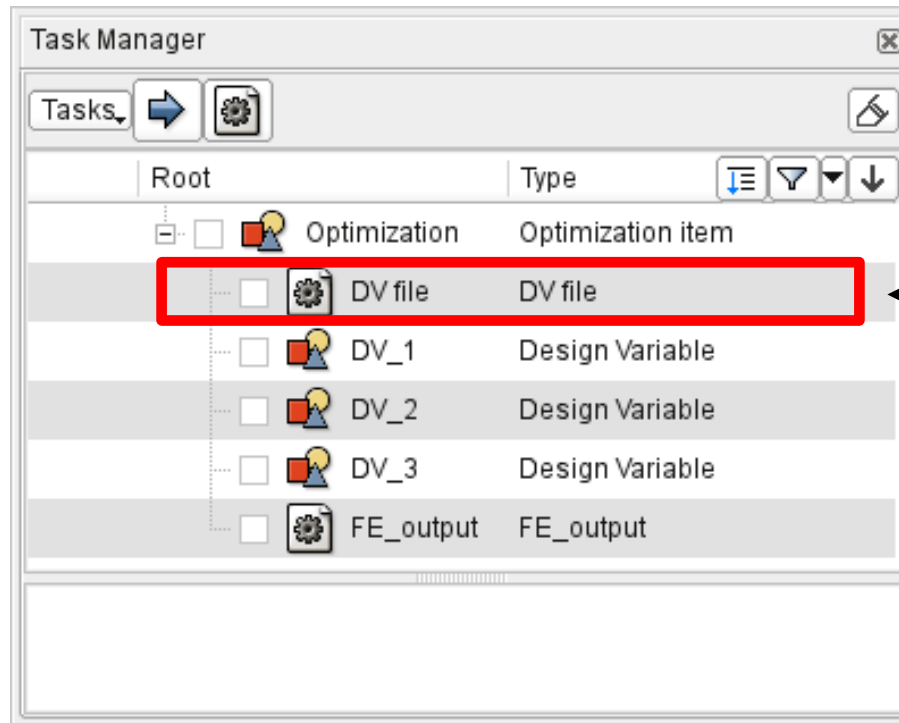

3 main task items

← **1. Design Variable File**

ANSA – Optimization Task

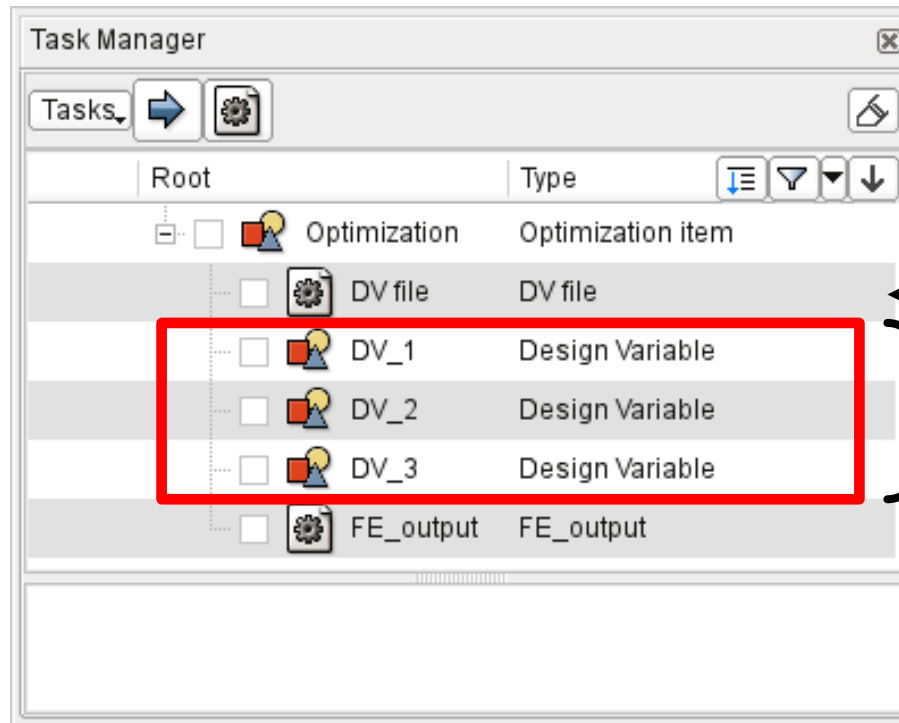

3 main task items

1. Design Variable File

2. Design Variables

ANSA – Optimization Task

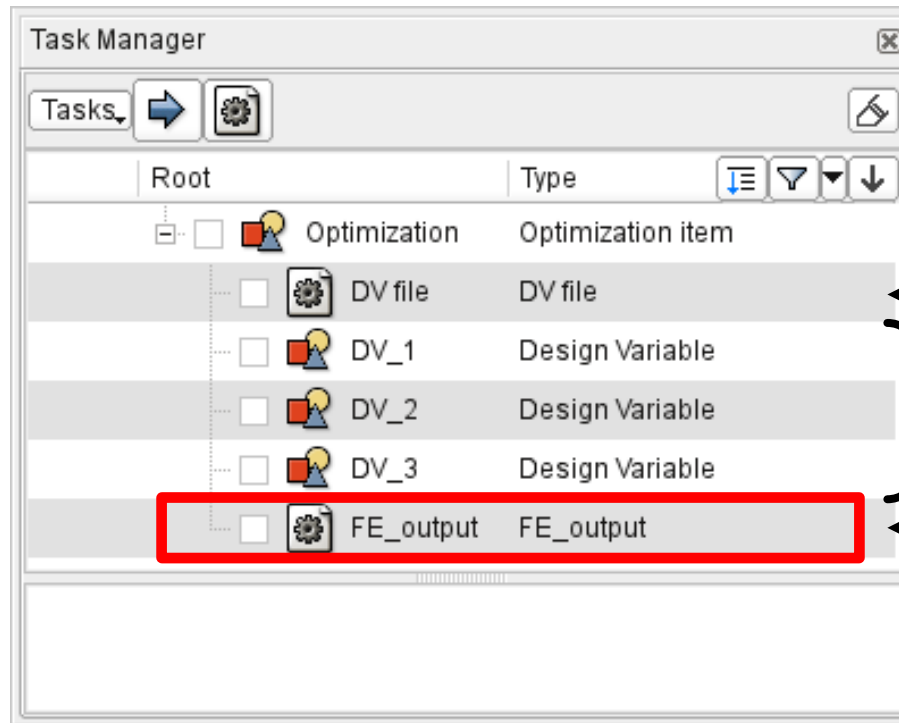

3 main task items

1. Design Variable File

2. Design Variables

3. Output Solver Deck

ANSA – Optimization Task

Design Variable File

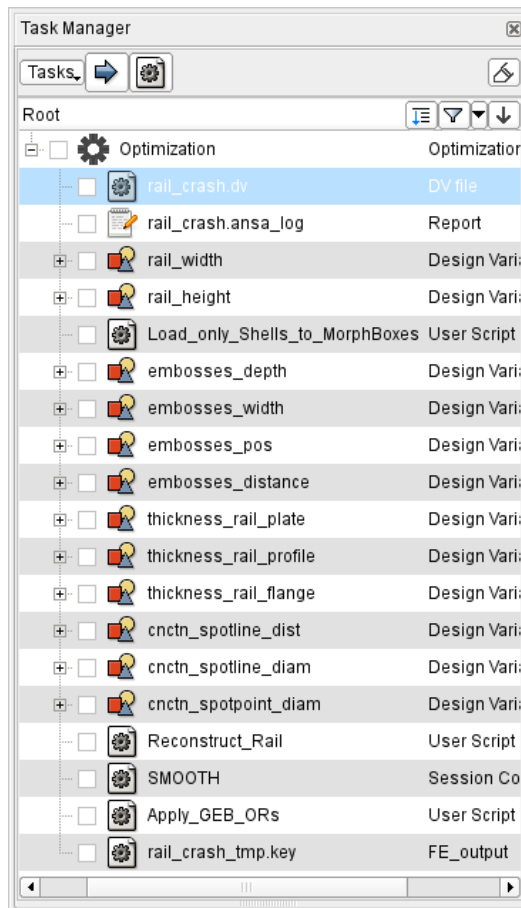

ANSA – Optimization Task

Design Variable File

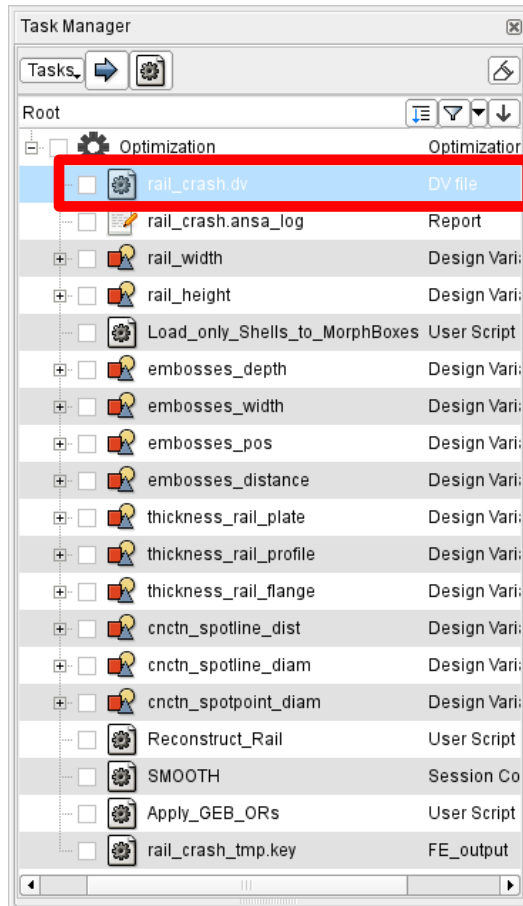

```
#
# ANSA_VERSION: 14.2.3
#
# file created by A N S A Mon Feb 17 17:13:25 2014
#
# Output from:
# /od1/lasso/Dirk30/PROJECTS/Optimierung_Rail_LS-OPT/Rail_MD0/rail_crash.ansa
#
# DESIGN VARIABLES
#-----
# ID | DESIGN VARIABLE NAME | TYPE | RANGE | CURRENT VALUE | MIN VALUE --> MAX VALUE | STEP
#-----
10, rail_width, REAL, BOUNDS, 10., -20., 20.
11, rail_height, REAL, BOUNDS, 10., -20., 20.
1, embosses_depth, REAL, BOUNDS, 7., 0., 7.
3, embosses_width, REAL, BOUNDS, 10., -10., 10.
2, embosses_pos, REAL, BOUNDS, -15., -50., 20.
7, embosses_distance, REAL, BOUNDS, -15., -15., 50.
4, thickness_rail_plate, REAL, STEP, 1.5, 0.5, 2., 0.1
5, thickness_rail_profile, REAL, STEP, 1.5, 0.5, 2., 0.1
8, thickness_rail_flange, REAL, STEP, 1.5, 0.5, 3., 0.1
6, cncnt_spotline_dist, REAL, BOUNDS, 50., 20., 100.
9, cncnt_spotline_diam, REAL, STEP, 5., 2., 10., 1.
12, cncnt_spotpoint_diam, REAL, STEP, 5., 2., 10., 1.
#-----
```

Correctly formatted for
import in LS-OPT

ANSA – Optimization Task

Design Variables → Morphing Parameters

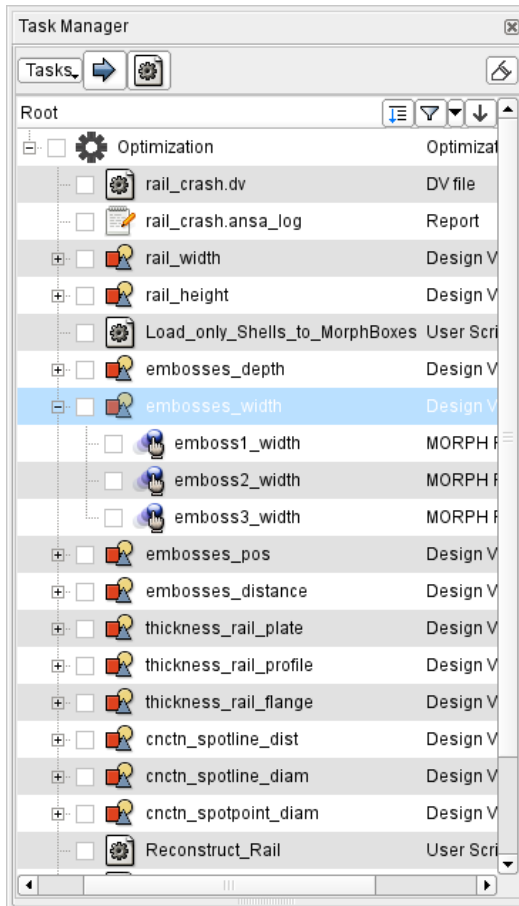

ANSA – Optimization Task

Design Variables → Morphing Parameters

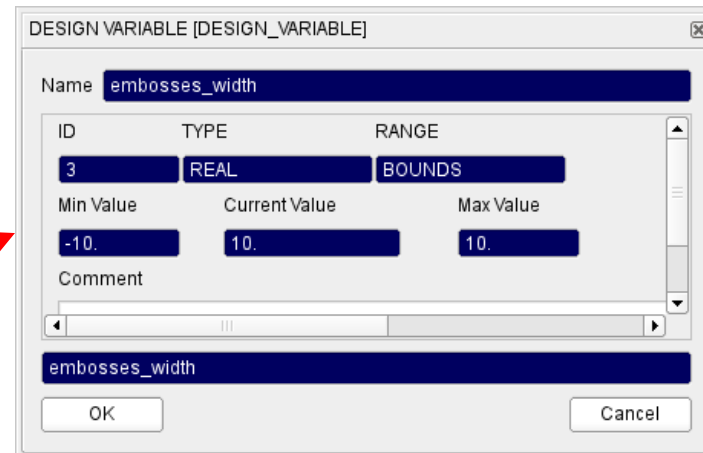
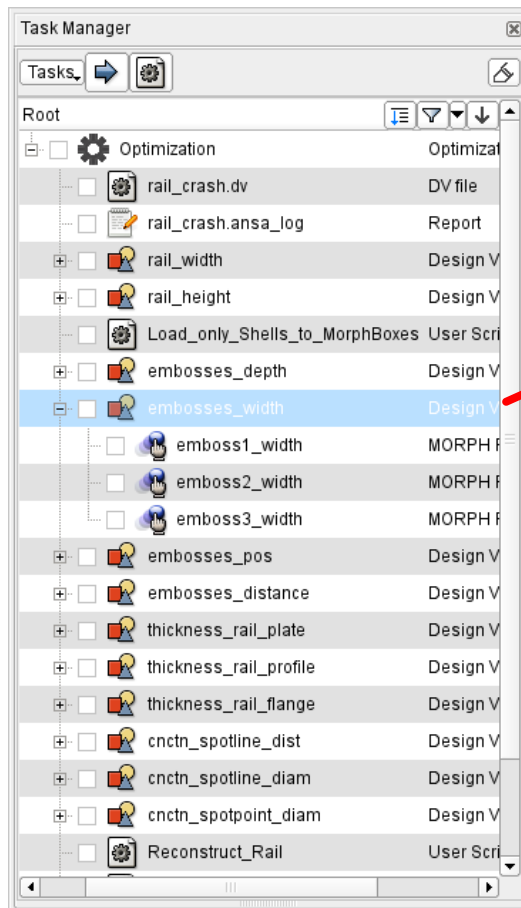

ANSA – Optimization Task

Design Variables → Morphing Parameters

Task Manager

Tasks

Root

- Optimization
 - rail_crash.dv DV file
 - rail_crash.ansa_log Report
 - rail_width Design V
 - rail_height Design V
 - Load_only_Shells_to_MorphBoxes User Scri
 - embosses_depth Design V
 - embosses_width Design V**
 - emboss1_width MORPH P
 - emboss2_width MORPH P
 - emboss3_width MORPH P
 - embosses_pos Design V
 - embosses_distance Design V
 - thickness_rail_plate Design V
 - thickness_rail_profile Design V
 - thickness_rail_flange Design V
 - cnctn_spotline_dist Design V
 - cnctn_spotline_diam Design V
 - cnctn_spotpoint_diam Design V
 - Reconstruct_Rail User Scri

DESIGN VARIABLE [DESIGN_VARIABLE]

Name **embosses_width**

ID	TYPE	RANGE
3	REAL	BOUNDS

Min Value: -10 Current Value: 10 Max Value: 10

Comment

embosses_width

OK Cancel

Morph Parameter Table for embosses_width

Id	Name	Type	Current value	Expression	Used by DV	At the end apply
11	emboss3_depth unt	Translate	embosses_width		embosses_depth	Nothing
13	emboss1_width	Translate	embosses_width/2		embosses_width	Nothing
14	emboss2_width	Translate	embosses_width/2		embosses_width	Nothing
15	emboss3_width	Translate	embosses_width/2		embosses_width	Nothing
16	embosses_pos	Translate	embosses_width		embosses_pos	Nothing

OK Cancel

ANSA – Optimization Task

Design Variables → Morphing Parameters

Shape modification

Design Variable = 10.0

Morphing Parameter

Width of depressions

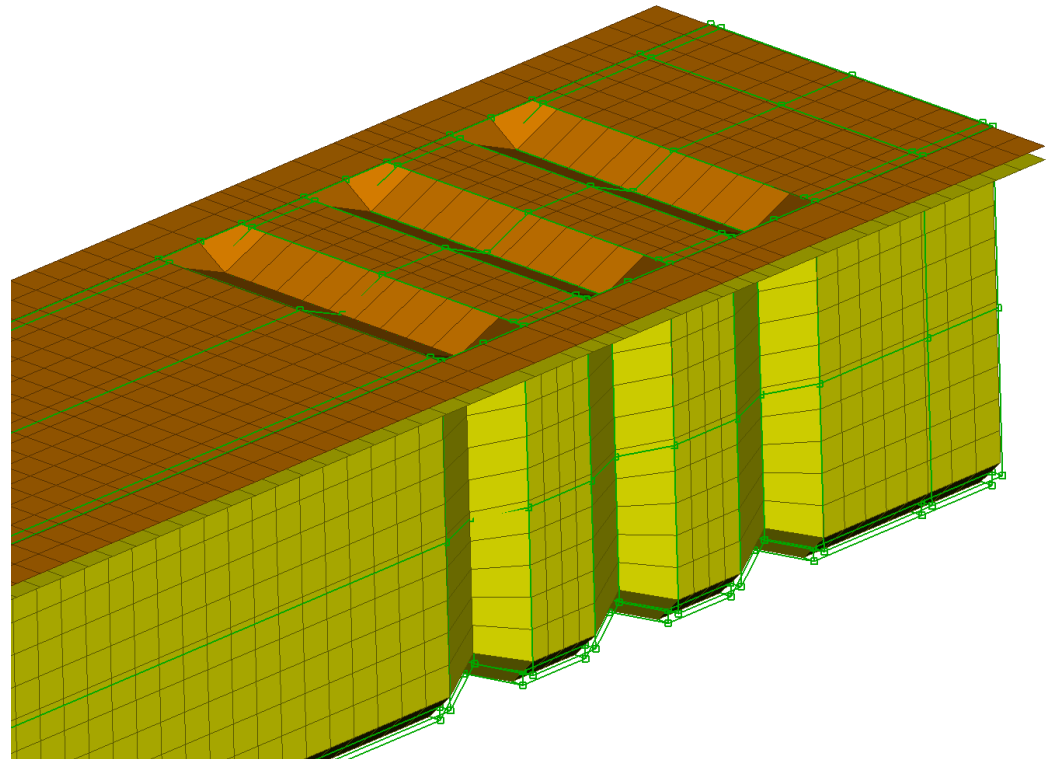

ANSA – Optimization Task

Design Variables → Morphing Parameters

Shape modification

Design Variable = -5.0

Morphing Parameter

Width of depressions

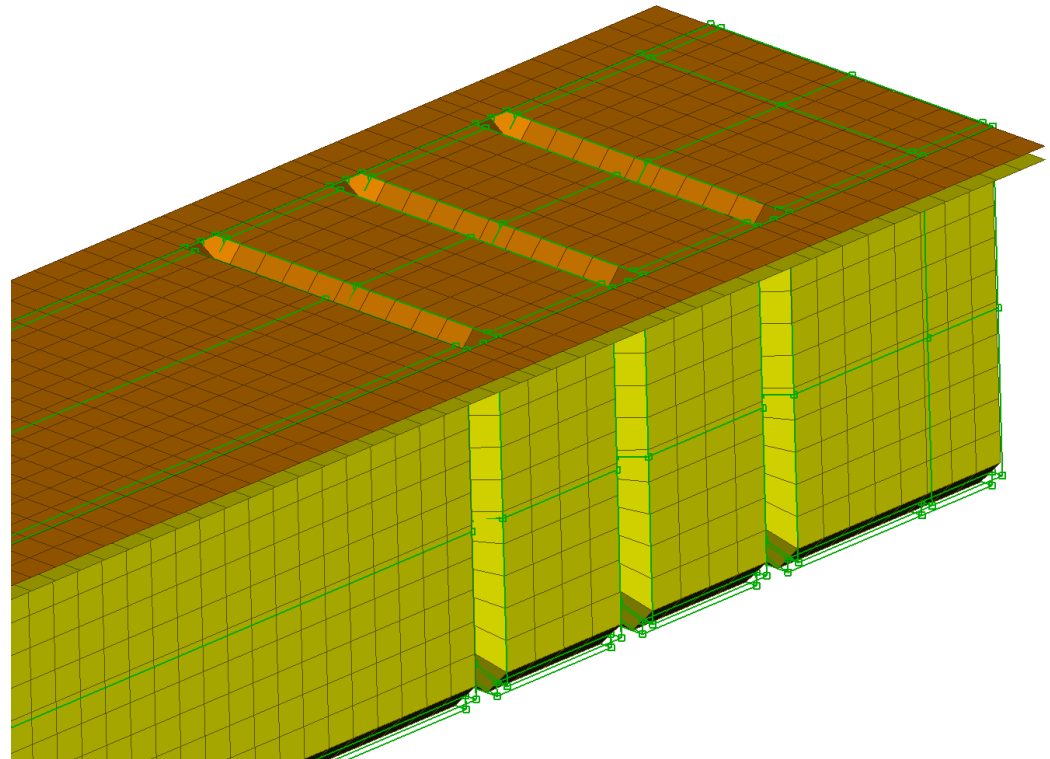

ANSA – Optimization Task

Design Variables → ANSA Parameters

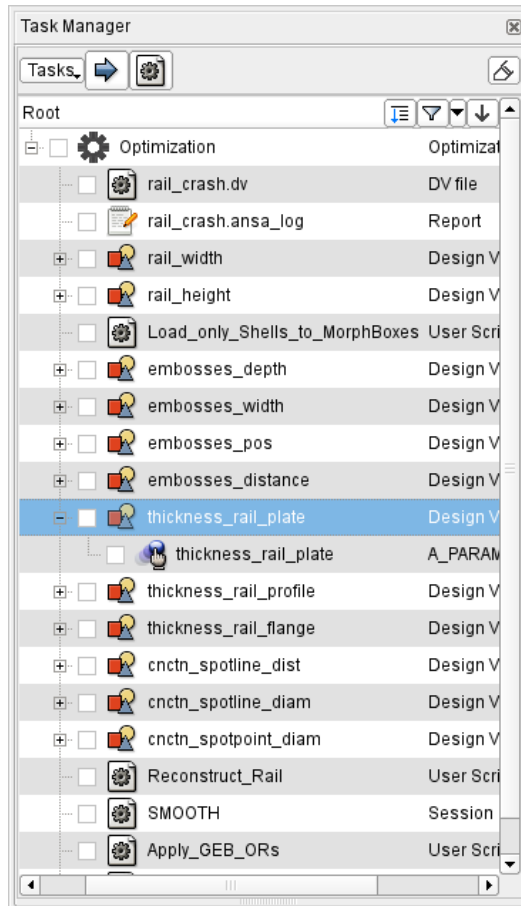

ANSA – Optimization Task

Design Variables → ANSA Parameters

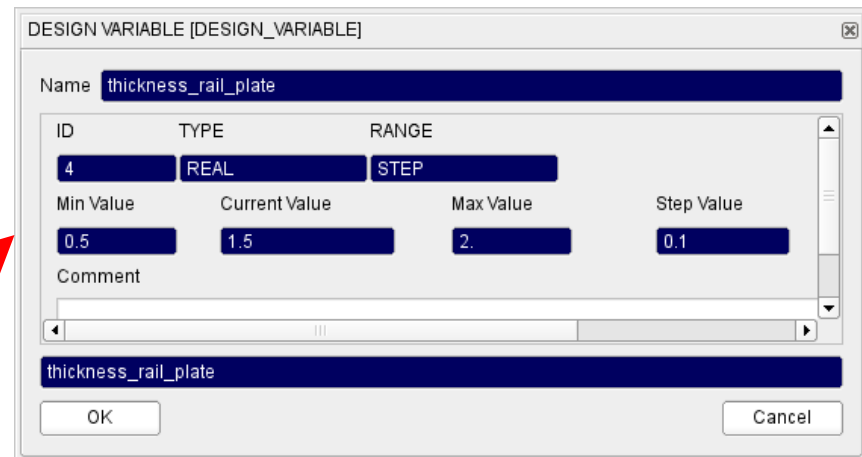
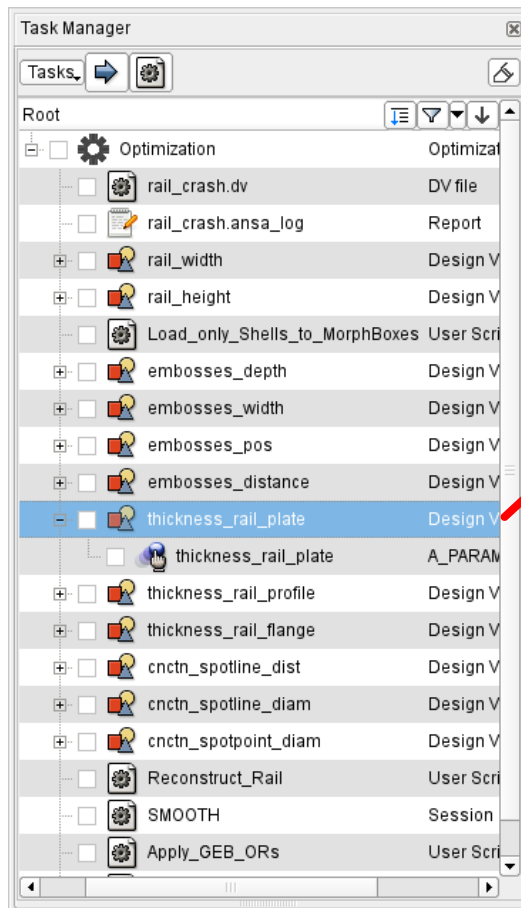

ANSA – Optimization Task

Design Variables → ANSA Parameters

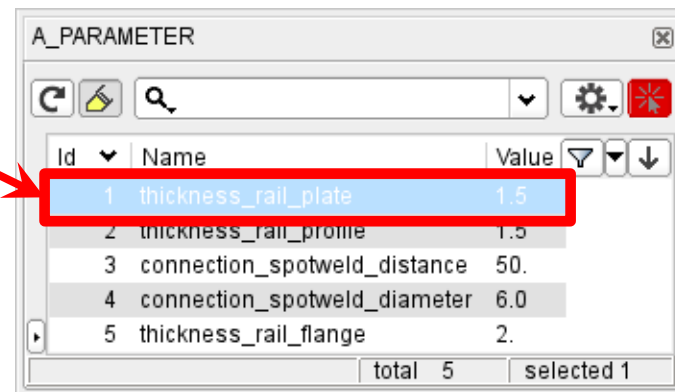
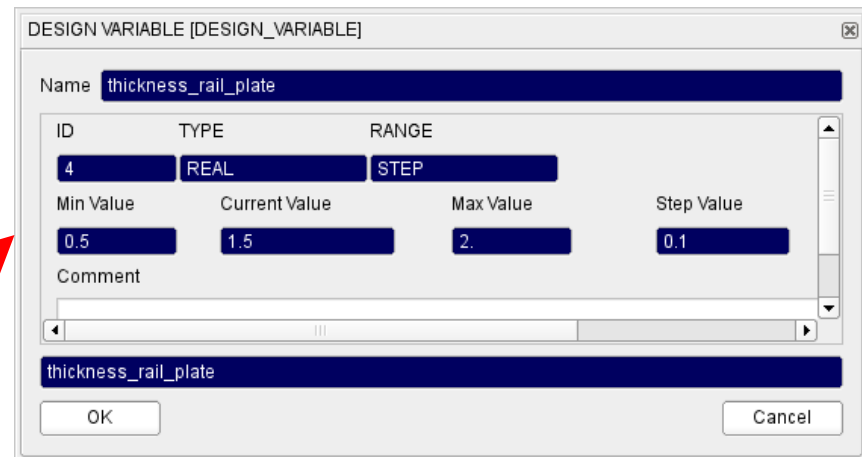
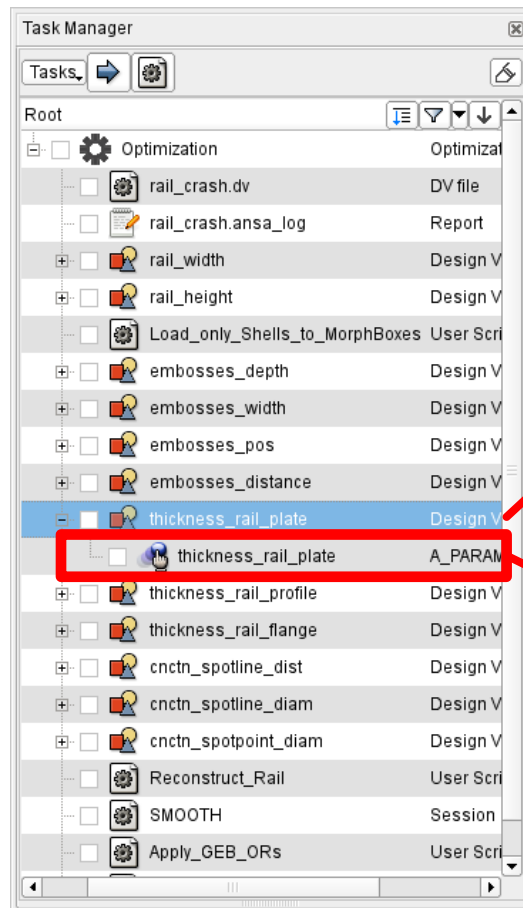

ANSA – Optimization Task

Design Variables → ANSA Parameters

Modification of shell thicknesses, materials, etc.

*PART & *SECTION_SHELL [SECTION_SHELL]

Name: rail_profile

FROZEN_ID: NO, FROZEN_DELETE: NO, DEFINED: YES, TRIM: NO, USE_IN_MODEL: YES

PID	SECID	MID	EOSID	HGID	GRAV	ADPOPT	TMID
3		2		3	0	0	
SECID	ELFORM	SHRF	NIP	PROPT	QR/IRID	QR	ICOMP
	16	1	2	1.0	QR	0.0	0
T1	T2	T3	T4	NLOC	MAREA	IDOF	EDGSET
1.5				0		0	

rail_profile

OK ColorEdit Cancel

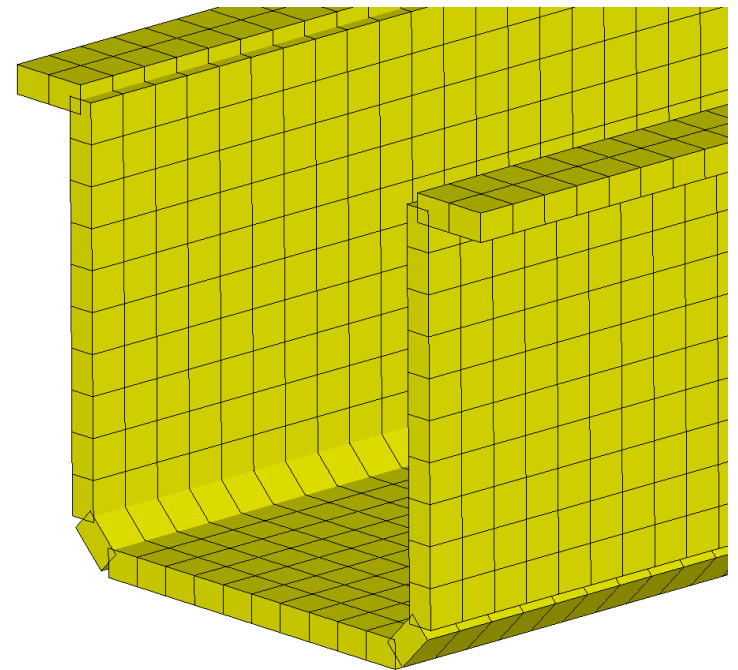

ANSA – Optimization Task

Design Variables → ANSA Parameters

Modification of shell thicknesses, materials, etc.

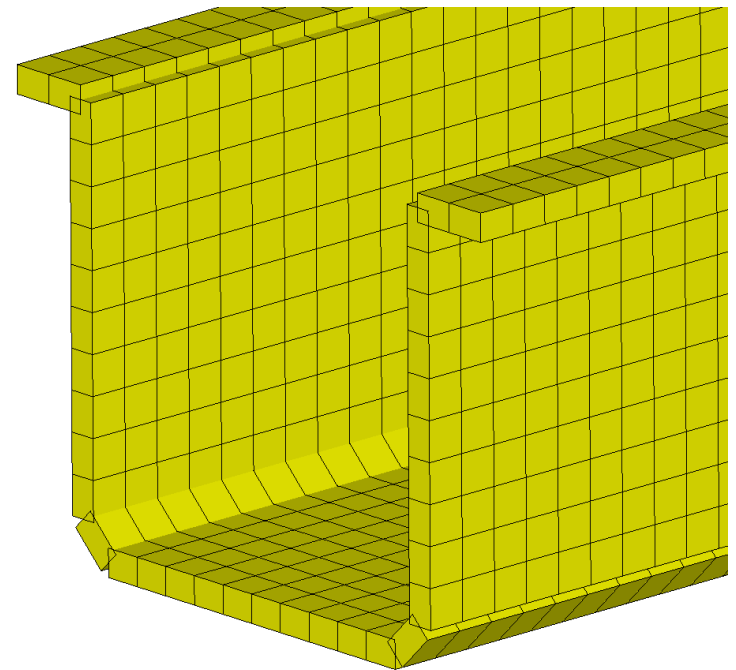
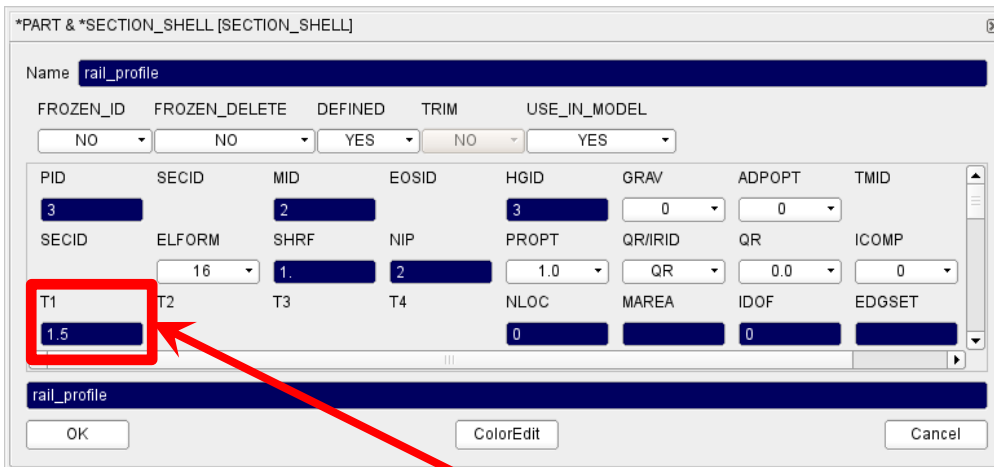

ANSA Parameter

Design Variable = 5.0

ANSA – Optimization Task

Design Variables → ANSA Parameters

Modification of shell thicknesses, materials, etc.

*PART & *SECTION_SHELL [SECTION_SHELL]

Name rail_profile

FROZEN_ID FROZEN_DELETE DEFINED TRIM USE_IN_MODEL
NO NO YES NO YES

PID	SECID	MID	EOSID	HGID	GRAV	ADPOPT	TMID
3		2		3	0	0	
SECID	ELFORM	SHRF	NIP	PROPT	QR/IRID	QR	ICOMP
	16	1	2	1.0	QR	0.0	0
T1	T2	T3	T4	NLOC	MAREA	IDOF	EDGSET
1.5				0		0	

OK ColorEdit Cancel

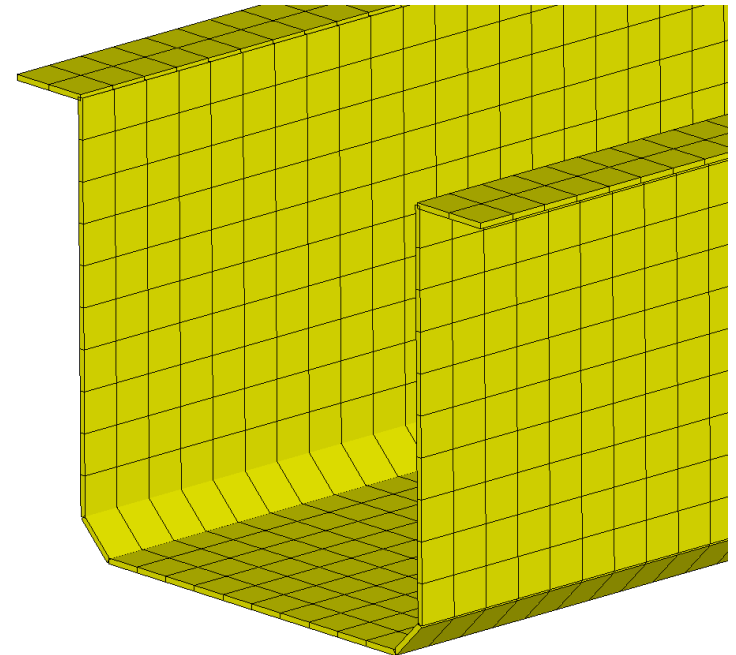

ANSA Parameter

Design Variable = 1.0

ANSA – Optimization Task

Design Variables → ANSA Parameters

Modification of connections (weld spot **distance**, diameter, etc.)

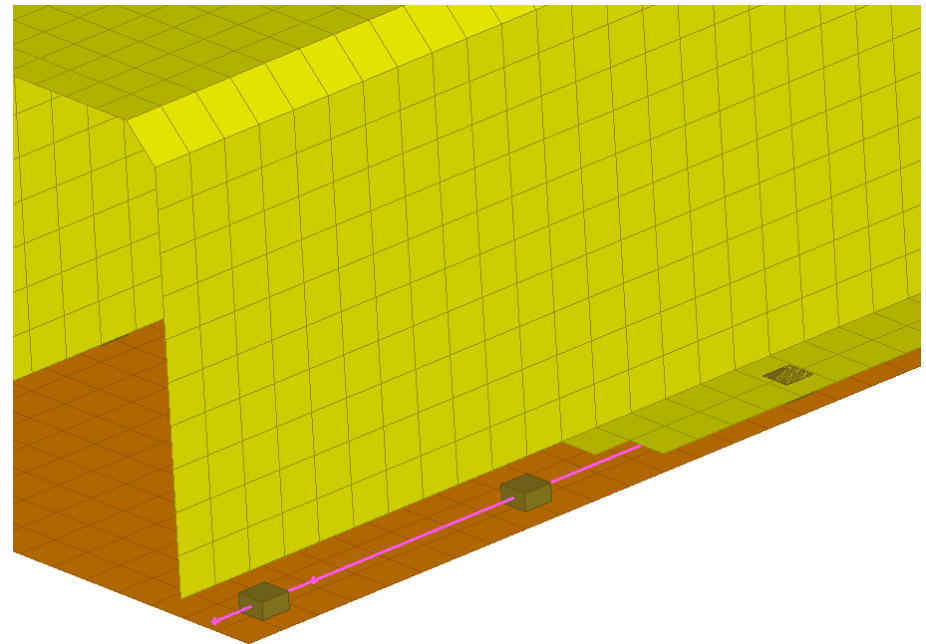
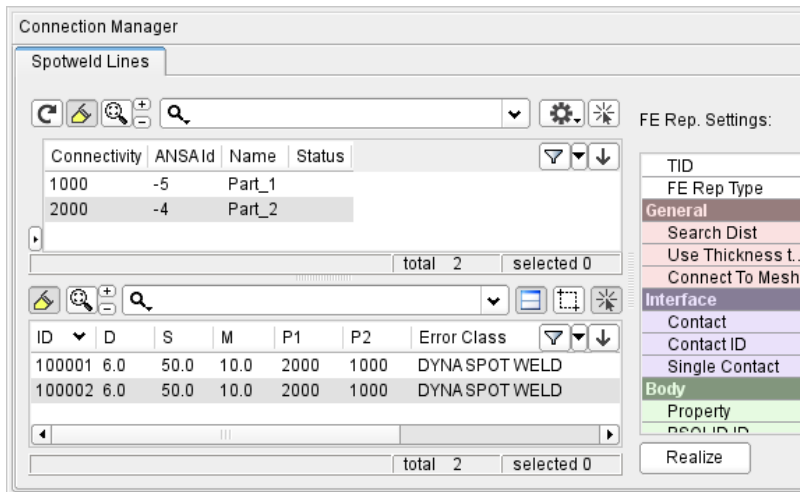

ANSA – Optimization Task

Design Variables → ANSA Parameters

Modification of connections (weld spot distance, diameter, etc.)

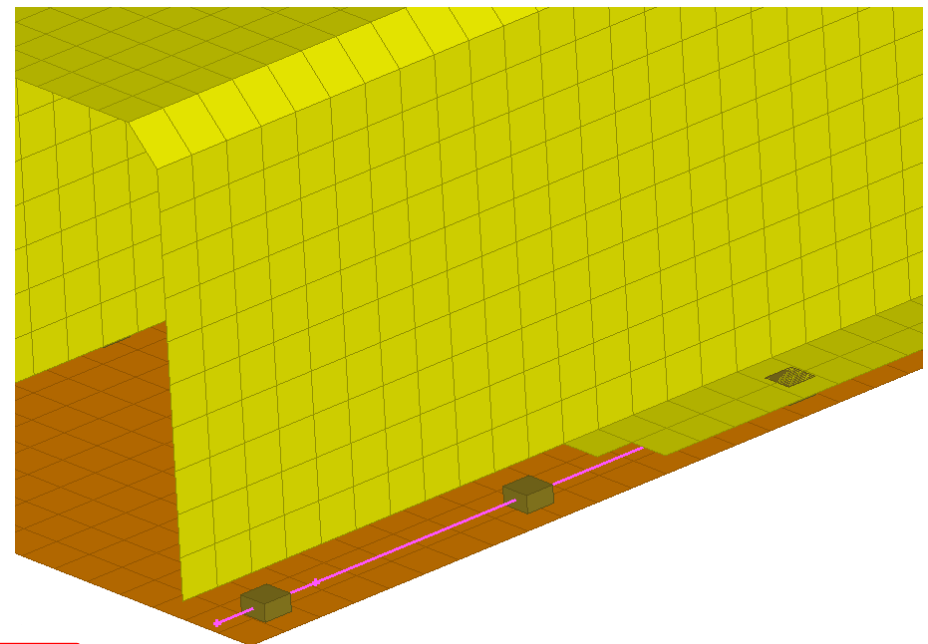
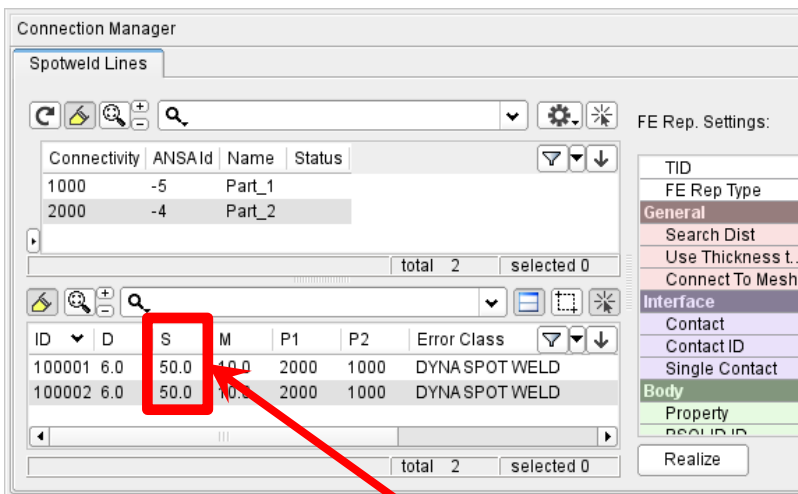

Design Variable (weld spot distance) = 50

ANSA – Optimization Task

Design Variables → ANSA Parameters

Modification of connections (weld spot distance, diameter, etc.)

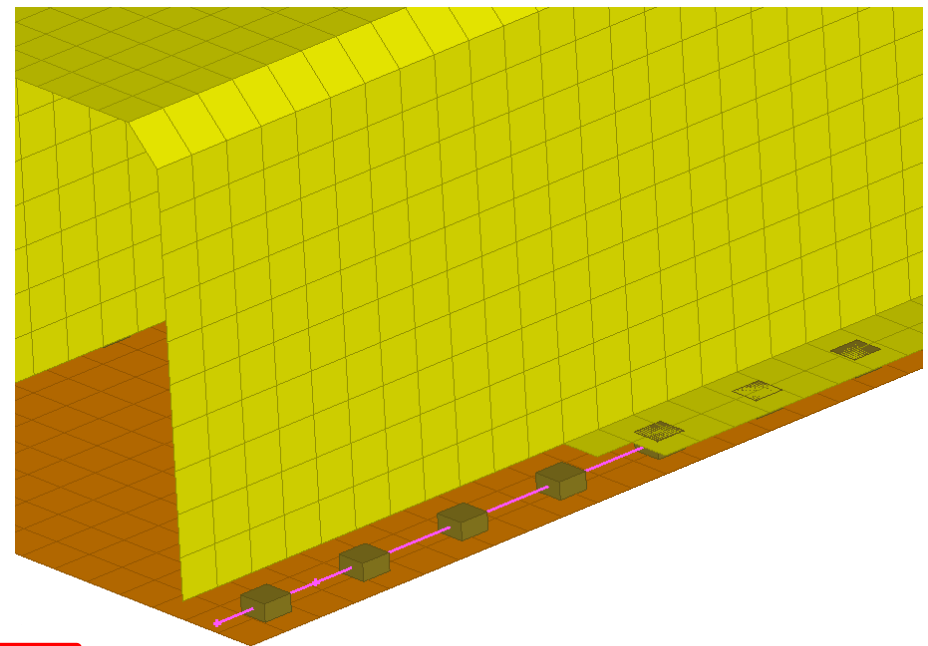
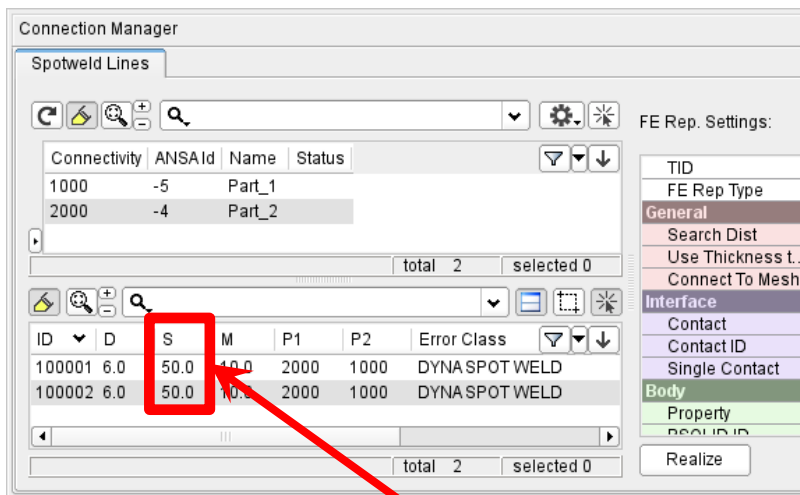

Design Variable (weld spot distance) = 20

ANSA – Optimization Task

Design Variables → ANSA Parameters

Modification of connections (weld spot distance, diameter, etc.)

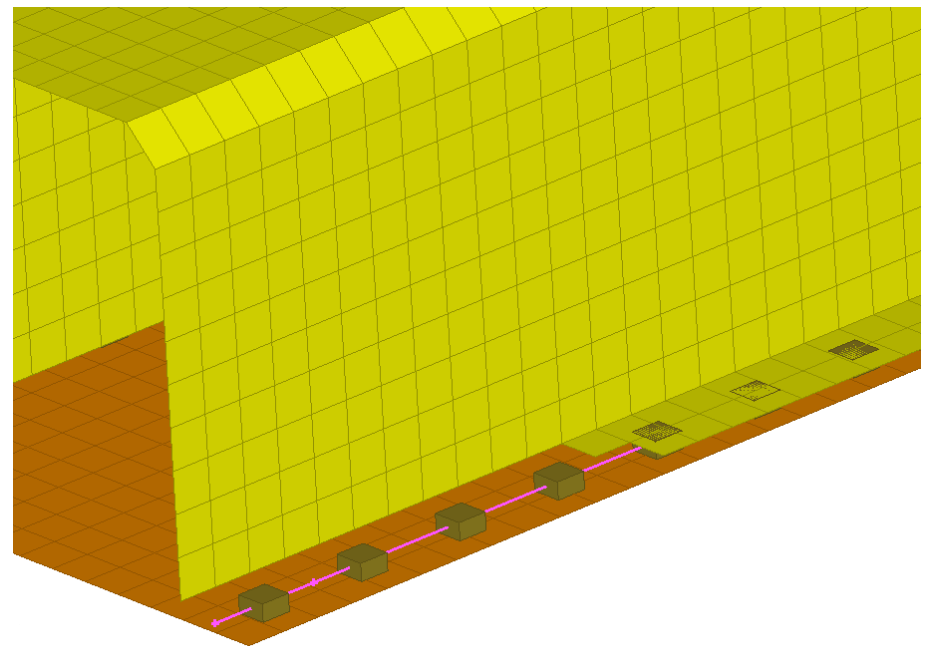
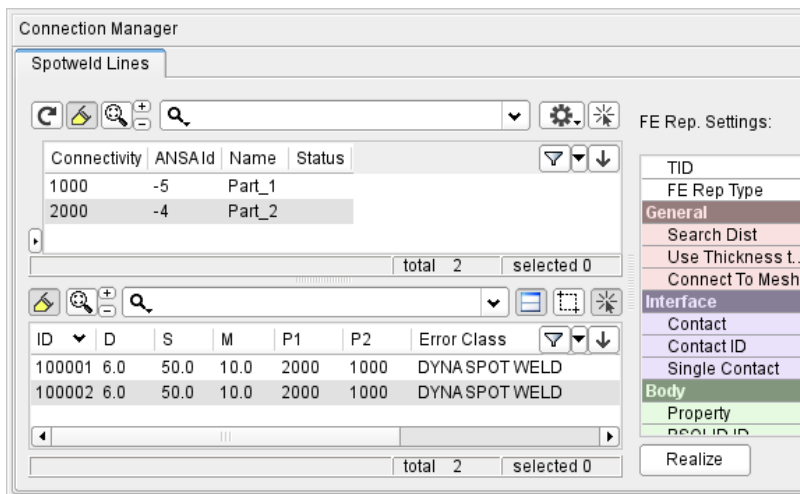

ANSA – Optimization Task

Design Variables → ANSA Parameters

Modification of connections (weld spot distance, diameter, etc.)

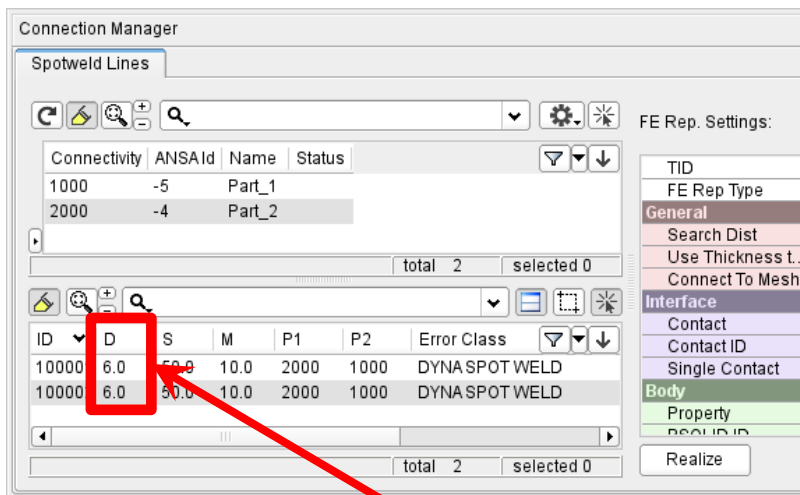

ANSA Parameter

Design Variable (weld spot diameter) = 6.0

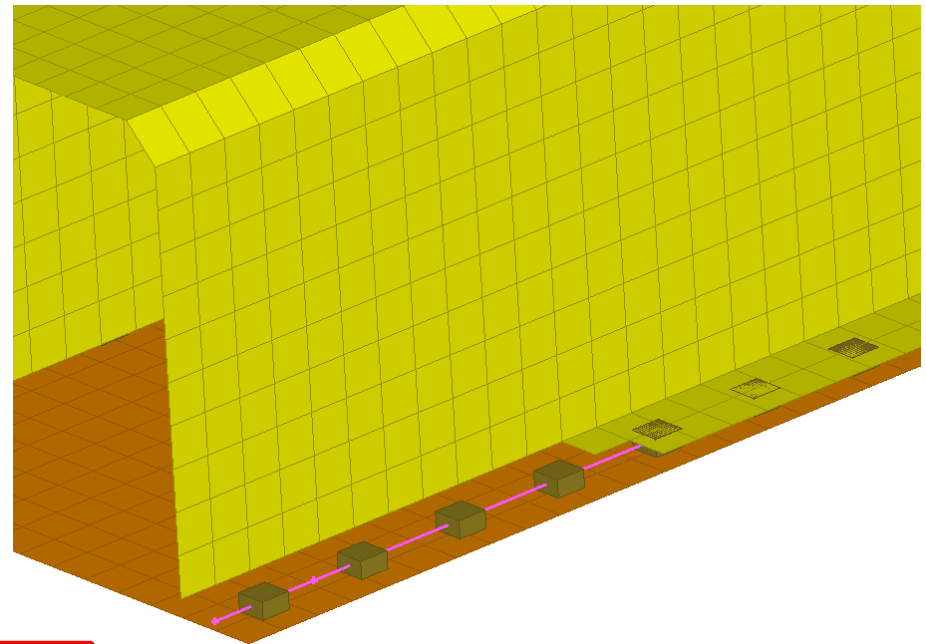

ANSA – Optimization Task

Design Variables → ANSA Parameters

Modification of connections (weld spot distance, diameter, etc.)

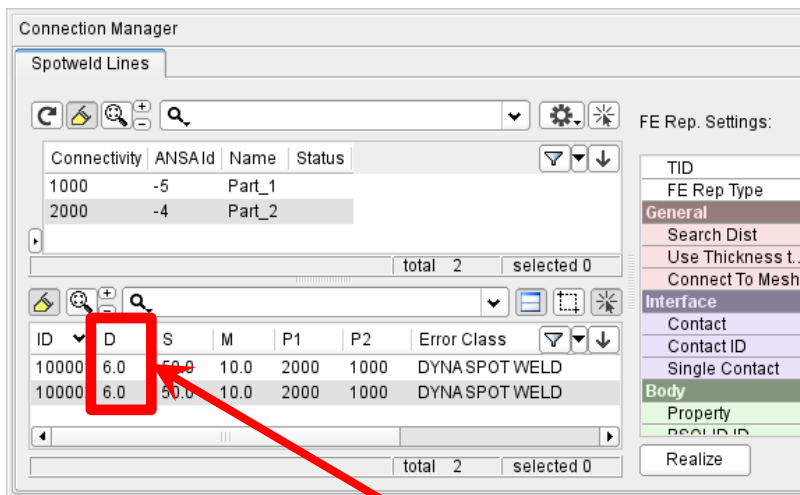

ANSA Parameter

Design Variable (weld spot diameter) = 3.0

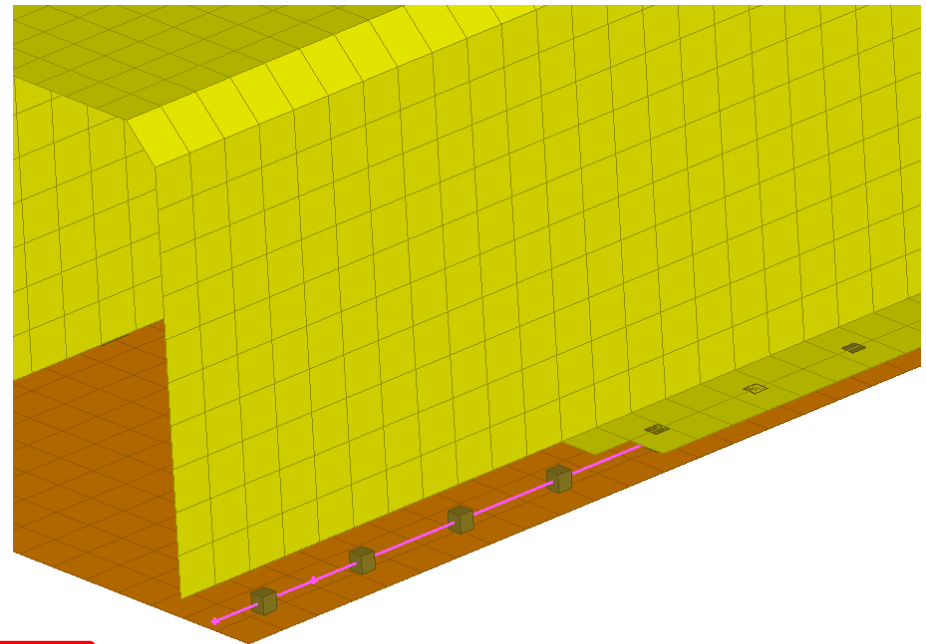

ANSA – Optimization Task

Simulation & DOE

- Checking Combinations of DV (Full Factorial) → Model Validity
- Checking Element Criteria

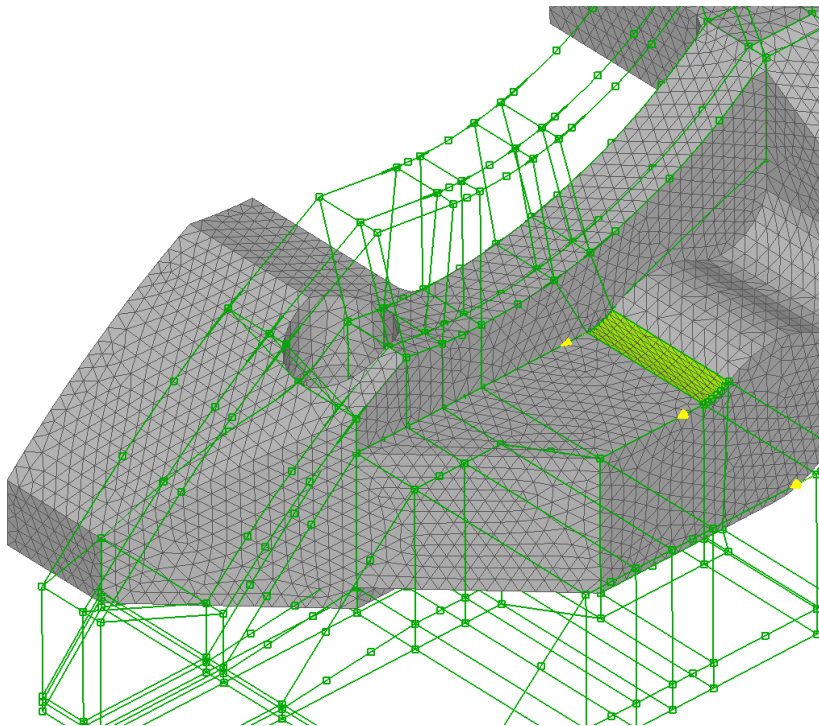

Simulate and DOE

Id	Name	Range	Min	Max
3	DV_Hoehe_Mittelsteg	Bounds	-5.	12.
2	DV_Breite_Seitensteg	Bounds	0.	10.
1	DV_Breite_Flachsteg_oben	Bounds	0.	20.
6	DV_Breite_Flachsteg_unten	Bounds	0.	25.
9	DV_Hoehe_Nase	Bounds	0.	10.
4	DV_Breite_Mittelsteg_ob_au	Bounds	-20.	13.
7	DV_Breite_Mittelsteg_ob_in	Bounds	-20.	13.
5	DV_Breite_Mittelsteg_un_au	Bounds	-13.	10.
8	DV_Breite_Mittelsteg_un_in	Bounds	-13.	10.
10	DV_Breite_Nase	Bounds	0.	20.

	DV_Breit	DV_Brei					
1	0.	0.					
2	2.	5.					
3	4.	10.					
4	6.	15.					
5	8.	20.					
6	10.	25.					

Algorithm..
 Simulate
 Steps: 6

Simulation info

ANSA – Optimization Task

Simulation & DOE

- Checking Combinations of DV (Full Factorial) → Model Validity
- Checking Element Criteria

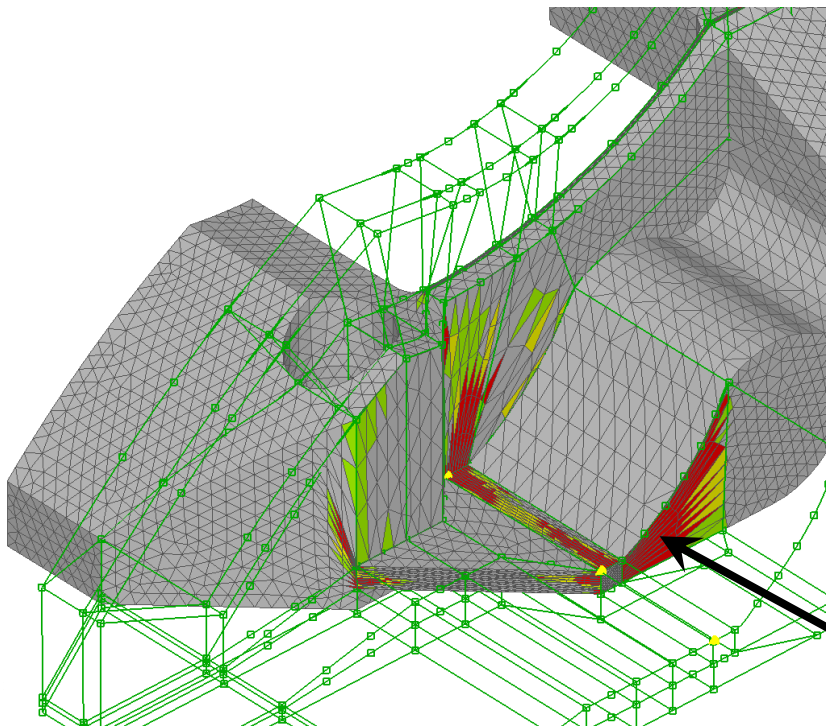

Simulate and DOE

Id	Name	Range	Min	Max
3	DV_Hoehe_Mittelsteg	Bounds	-5.	12.
2	DV_Breite_Seitensteg	Bounds	0.	10.
1	DV_Breite_Flachsteg_oben	Bounds	0.	20.
6	DV_Breite_Flachsteg_unten	Bounds	0.	25.
9	DV_Hoehe_Nase	Bounds	0.	10.
4	DV_Breite_Mittelsteg_oben	Bounds	-20.	13.
7	DV_Breite_Mittelsteg_oben	Bounds	-20.	13.
5	DV_Breite_Mittelsteg_unten	Bounds	-13.	10.
8	DV_Breite_Mittelsteg_unten	Bounds	-13.	10.
10	DV_Breite_Nase	Bounds	0.	20.

	DV_Breit	DV_Brei							
1	0.	0.							
2	2.	5.							
3	4.	10.							
4	6.	15.							
5	8.	20.							
6	10.	25.							

Simulate ▾ Run Task Experiments ▾ Clear table

Algorithm..
Simulate ▾
Generate Steps: 6

Simulation info

Failed elements

ANSA – Optimization Task

Additional commands for improving mesh quality

Fix Quality, Smooth, Reconstruct, etc. for morphed mesh

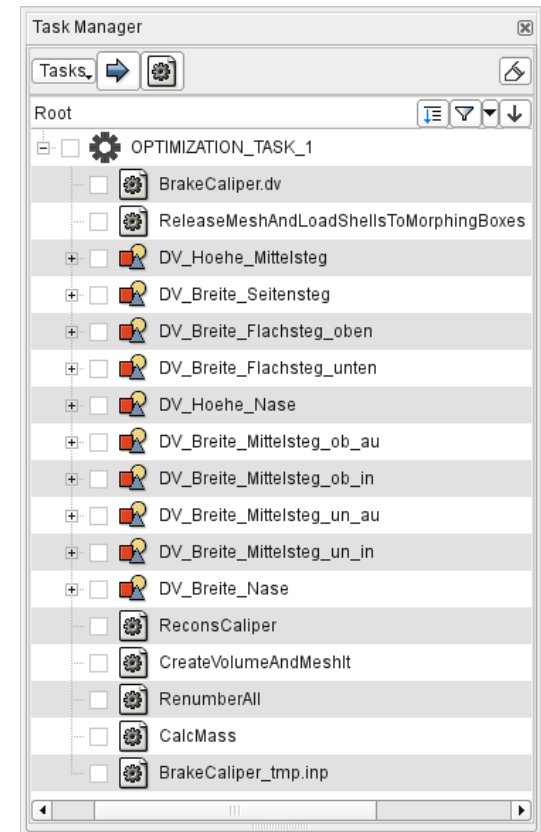
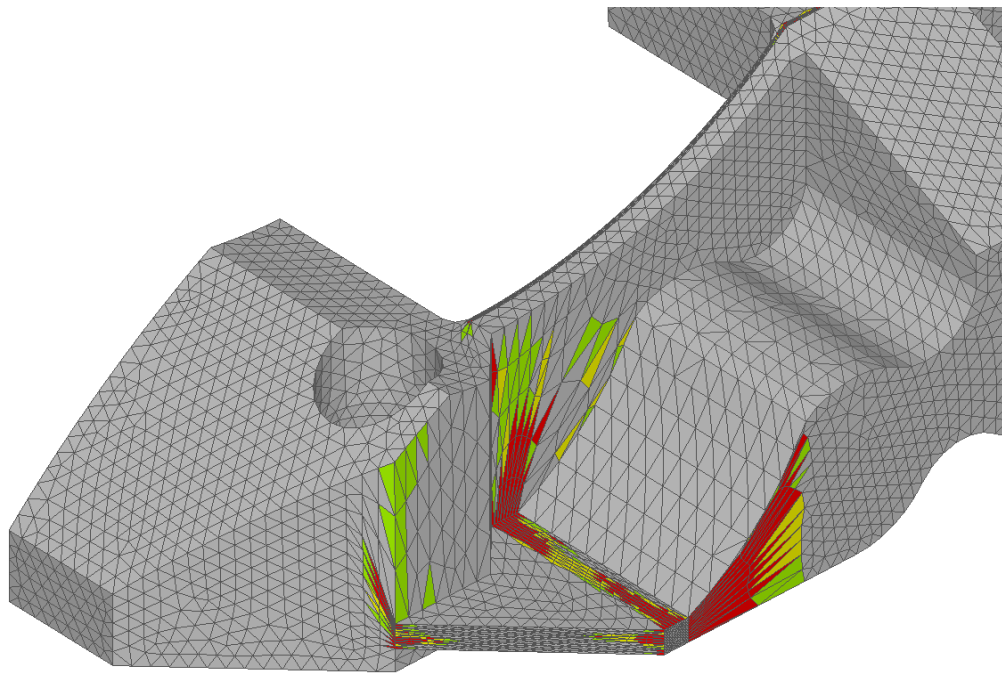

ANSA – Optimization Task

Additional commands for improving mesh quality

Fix Quality, Smooth, Reconstruct, etc. for morphed mesh

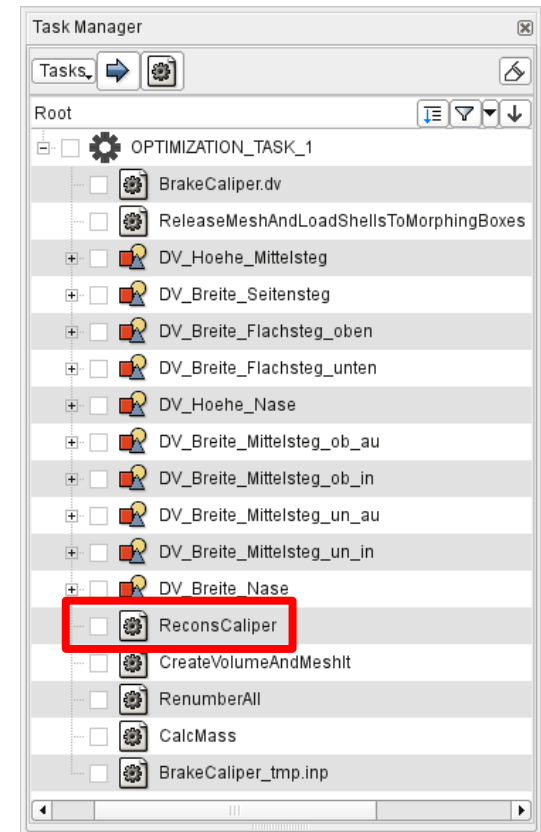
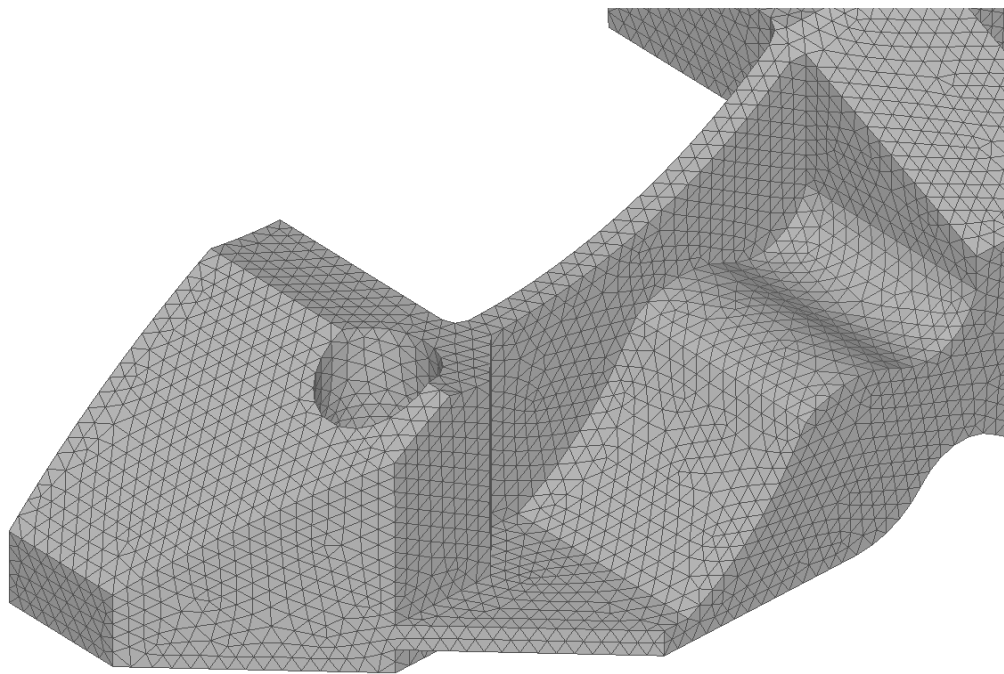

META – OptimizerSetup Toolbar

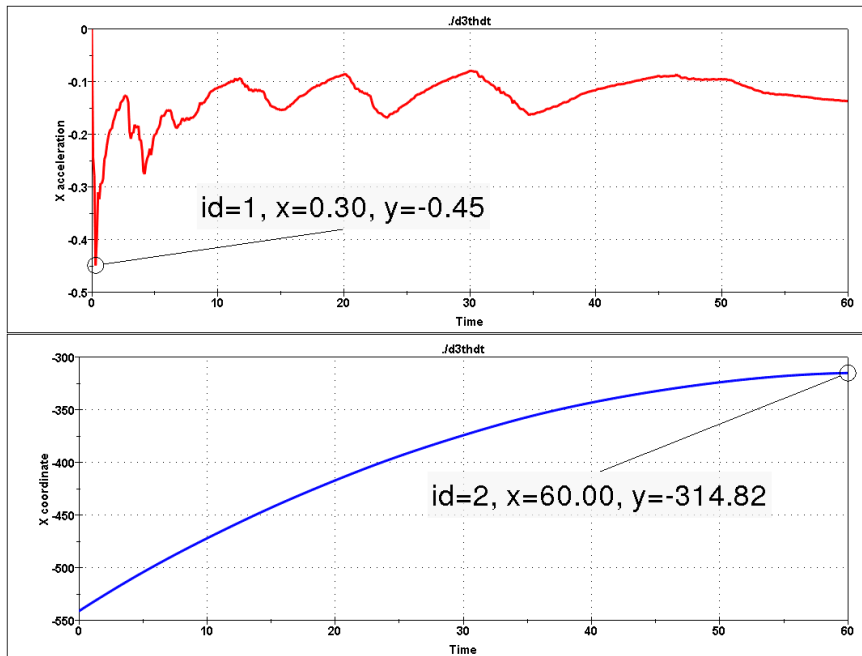

The screenshot shows the 'OptimizerSetup' dialog box with the following sections and controls:

- Response Variables**
 - Responses: 1 acceleration
 - Buttons: Add, Print Response Values, Update Response Values (Current, All), Remove (Current, All), Rename Response
- History Variables**
 - Histories: (empty)
 - Buttons: Add, Print History Values, Update History Values (Current, All), Remove (Current, All), Rename History
- Export Session

META – OptimizerSetup Toolbar

- Responses from annotations, variables, advanced expressions

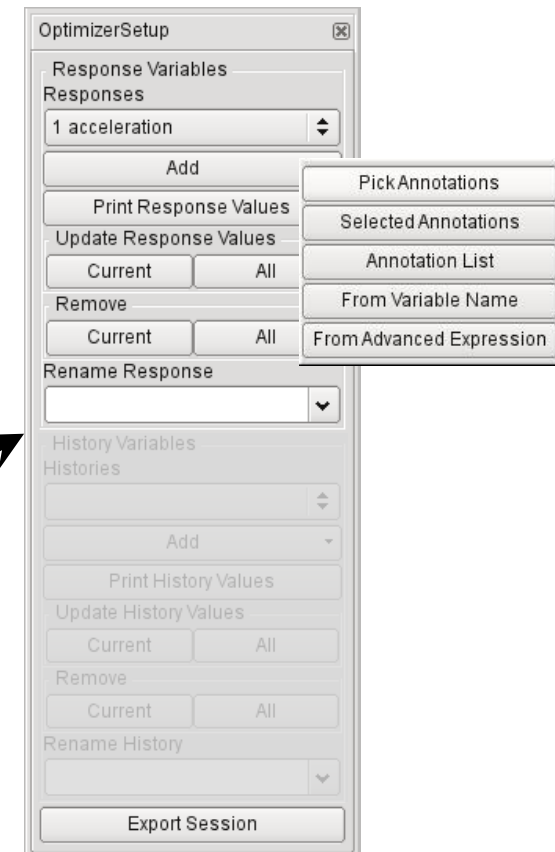
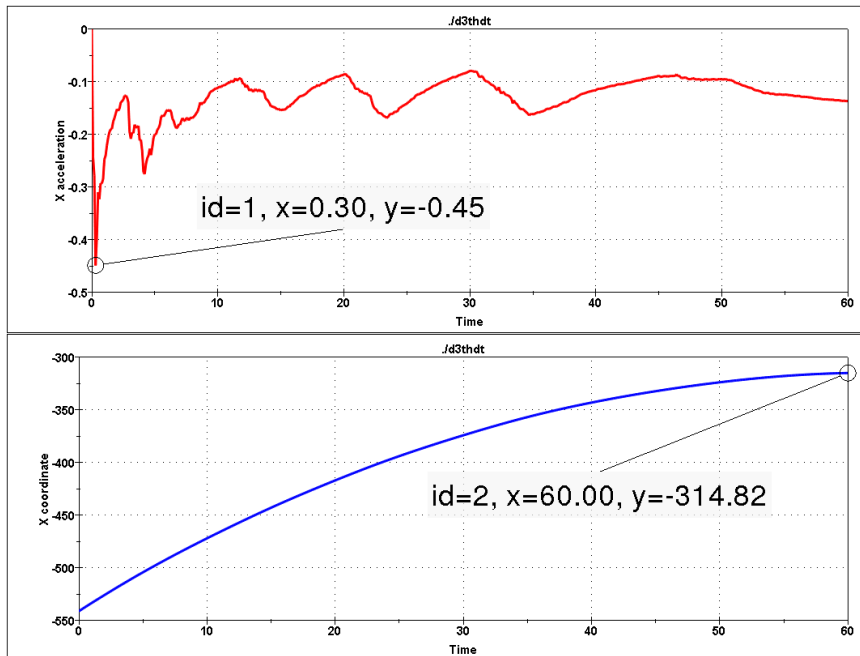

META – OptimizerSetup Toolbar

- Responses from annotations, variables, advanced expressions
- Histories from 2D plot curves

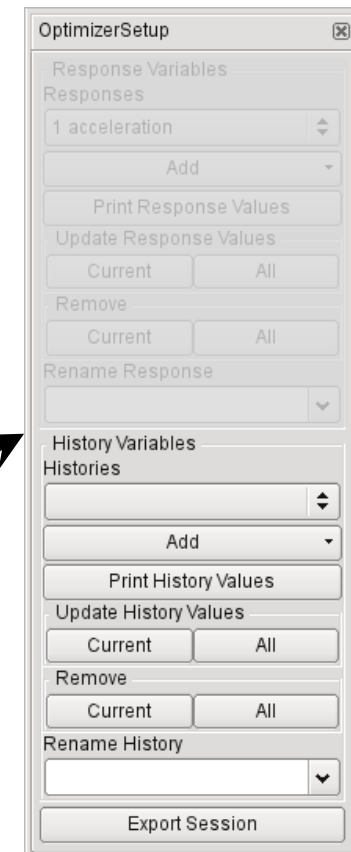
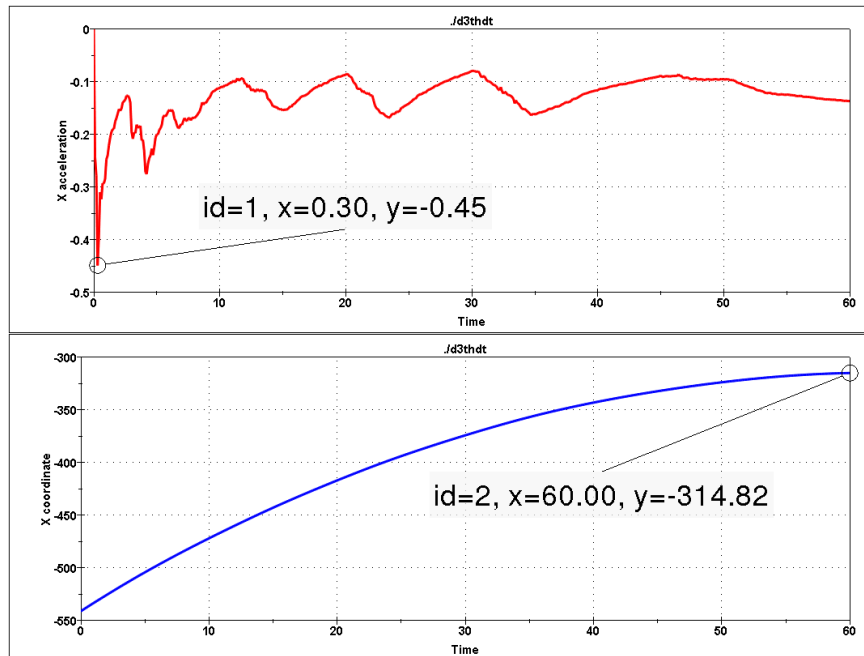

META – OptimizerSetup Toolbar

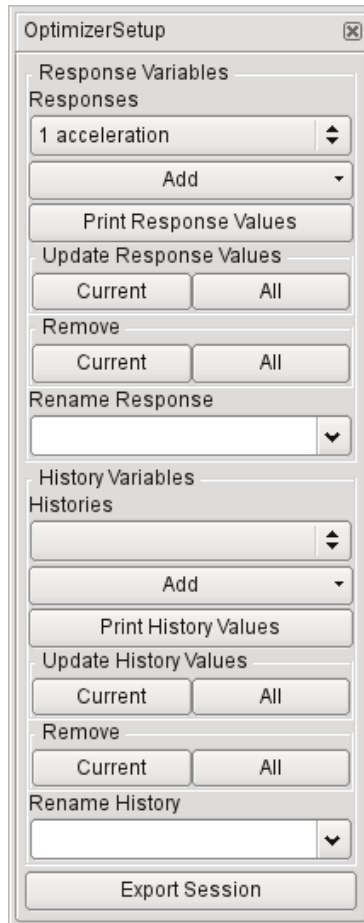

META – OptimizerSetup Toolbar

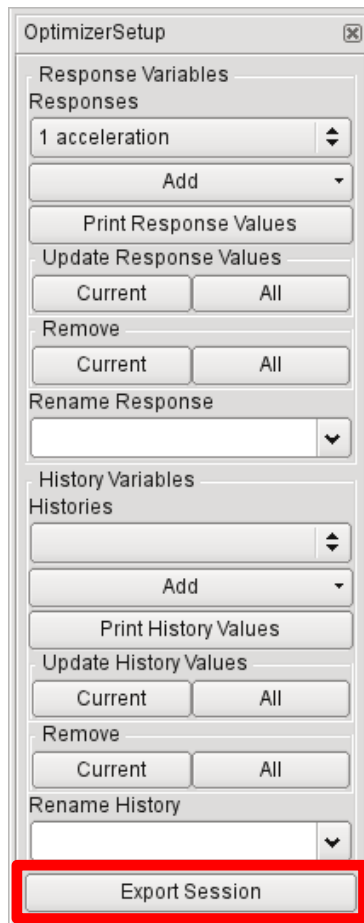

Exports:

- Session file (for reproduction of results extraction)
- Output file, containing responses and histories

```
#OptimizerSetup Response & history File created by META post  
RESPONSES  
1, acceleration, -1.18  
2, intrusion, -440.07  
END
```

Correctly formatted for
import in LS-OPT

Connecting ANSA to LS-OPT

Connecting ANSA to LS-OPT

Stage for ANSA

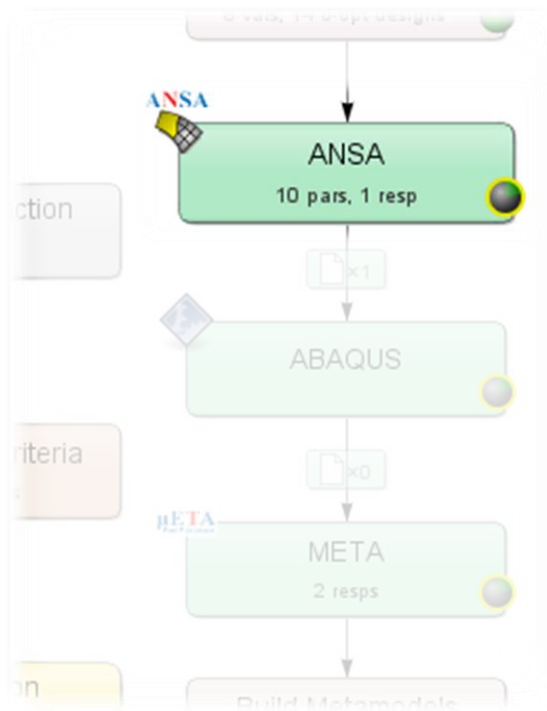

Connecting ANSA to LS-OPT

Stage for ANSA

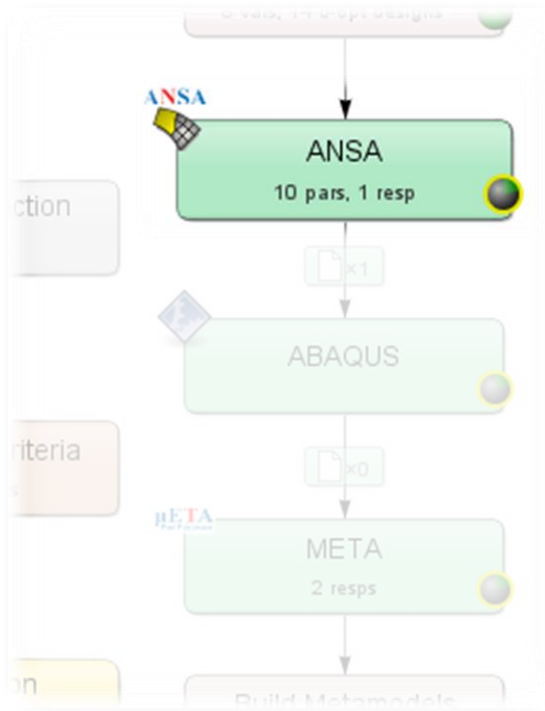

The screenshot shows the 'Stage ANSA' configuration window in LS-OPT. The window has tabs for 'Setup', 'Parameters', 'Histories', 'Responses', and 'File Operations'. The 'General' section includes the following fields:

- Package Name: ANSA
- Command: `ansa -lm_retry 10 -gui ANSA_D30`
- DV File: `BrakeCaliper.dv`
- Model Database: `BrakeCaliper.ansa`

Below the 'General' section is the 'Execution' section, which includes a 'Resources' table:

Resource	Units per job	Global limit	Delete
ANSA	1	3	x

At the bottom of the window, there are several checkboxes for execution options: 'Use Queuing', 'Use LSTCVM proxy', 'Environment Variables', and 'Run Jobs in Directory of Stage'. An 'OK' button is located at the bottom right.

Connecting ANSA to LS-OPT

Stage for ANSA

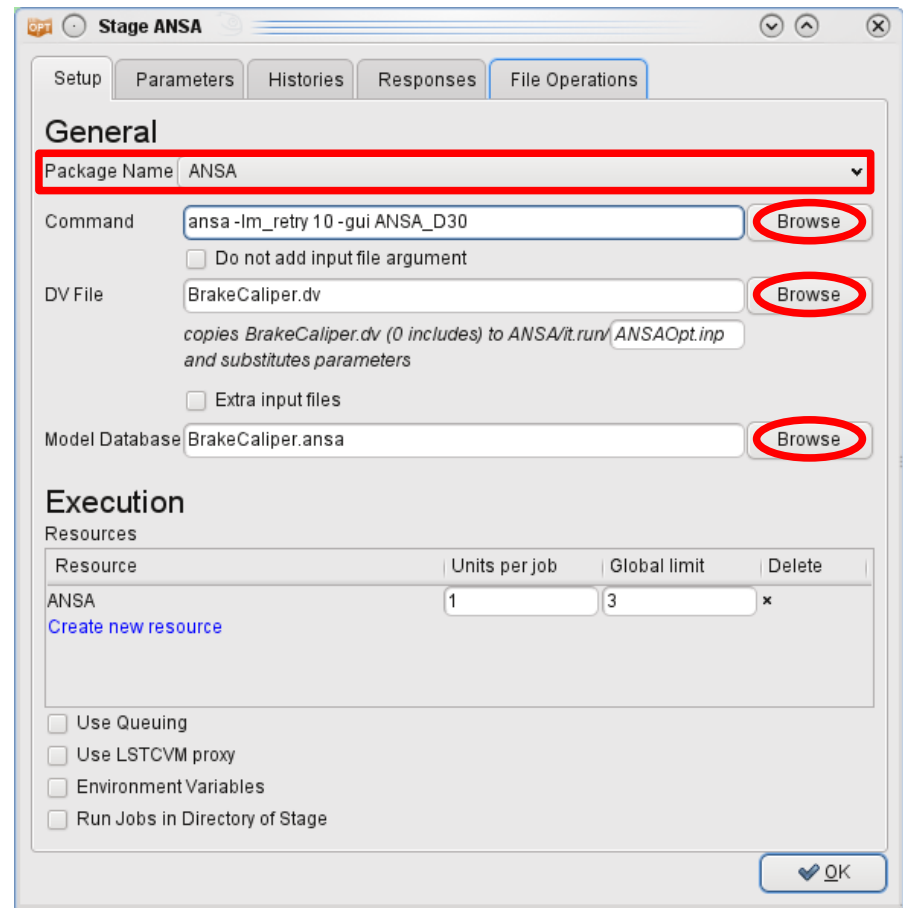
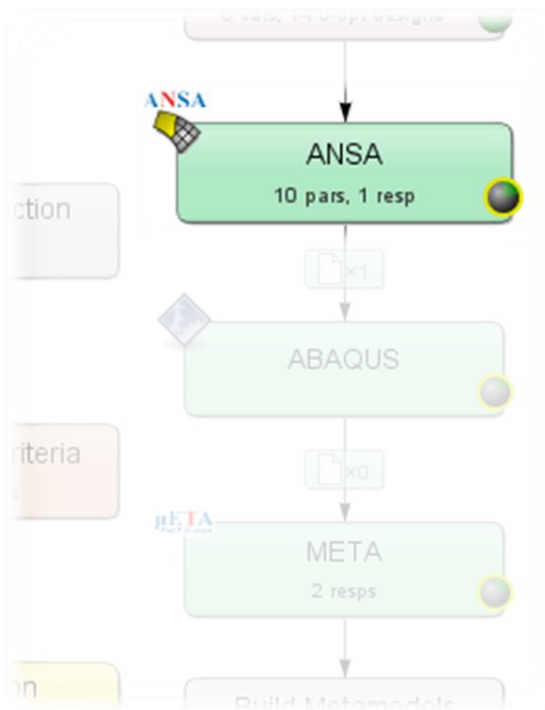

Connecting ANSA to LS-OPT

ANSA → DV file → Design Variables in LS-OPT

```
#
# ANSA_VERSION: 15.0.1
#
# file created by ANSA Fri Feb 14 15:49:00 2014
#
# Output from:
# ansaout.ansa
#
# DESIGN VARIABLES
#-----
# ID | DESIGN VARIABLE NAME | TYPE | RANGE | CURRENT VA
#-----
3, DV_Hoehe_Mittelsteg, REAL, BOUNDS, 0., -5.
2, DV_Breite_Seitensteg, REAL, BOUNDS, 0., -5.
1, DV_Breite_Flachsteg_oben, REAL, BOUNDS, 0., -5.
6, DV_Breite_Flachsteg_unten, REAL, BOUNDS, 0., -5.
9, DV_Hoehe_Nase, REAL, BOUNDS, 0., 0., 10.
4, DV_Breite_Mittelsteg_ob_au, REAL, BOUNDS, 0., -5.
7, DV_Breite_Mittelsteg_ob_in, REAL, BOUNDS, 0., -5.
5, DV_Breite_Mittelsteg_un_au, REAL, BOUNDS, 0., -5.
8, DV_Breite_Mittelsteg_un_in, REAL, BOUNDS, 0., -5.
10, DV_Breite_Nase, REAL, BOUNDS, 0., 0., 20.
#-----
```

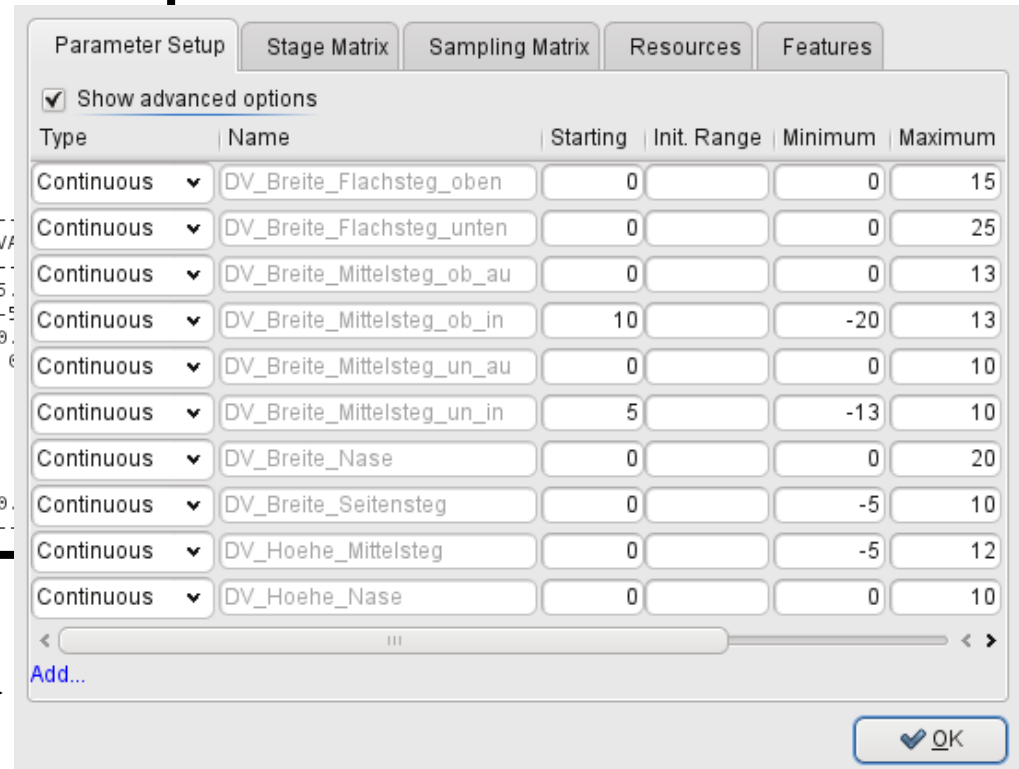

Type	Name	Starting	Init. Range	Minimum	Maximum
Continuous	DV_Breite_Flachsteg_oben	0		0	15
Continuous	DV_Breite_Flachsteg_unten	0		0	25
Continuous	DV_Breite_Mittelsteg_ob_au	0		0	13
Continuous	DV_Breite_Mittelsteg_ob_in	10		-20	13
Continuous	DV_Breite_Mittelsteg_un_au	0		0	10
Continuous	DV_Breite_Mittelsteg_un_in	5		-13	10
Continuous	DV_Breite_Nase	0		0	20
Continuous	DV_Breite_Seitensteg	0		-5	10
Continuous	DV_Hoehe_Mittelsteg	0		-5	12
Continuous	DV_Hoehe_Nase	0		0	10

Add...

OK

Connecting ANSA to LS-OPT

Fine Tuning of Design Variables, e.g.

Parameter Setup | Stage Matrix | Sampling Matrix | Resources | Features

Show advanced options

Type	Name	Starting	Init. Range	Minimum	Maximum
Continuous	DV_Breite_Flachsteg_oben	0	8	0	15
Continuous	DV_Breite_Flachsteg_unten	0	12	0	25
Continuous	DV_Breite_Mittelsteg_ob_au	0	6	0	13
Dependent	DV_Breite_Mittelsteg_ob_in	Definition: DV_Breite_Mittelsteg_ob_au			
Continuous	DV_Breite_Mittelsteg_un_au	0	5	0	10
Dependent	DV_Breite_Mittelsteg_un_in	Definition: DV_Breite_Mittelsteg_un_au			
Continuous	DV_Breite_Nase	0	10	0	20
Continuous	DV_Breite_Seitensteg	0	8	-5	10
Continuous	DV_Hoehe_Mittelsteg	0	8	-5	12
Continuous	DV_Hoehe_Nase	0	5	0	10

< Add... >

OK

Connecting ANSA to LS-OPT

Fine Tuning of Design Variables, e.g.

- Ranges

Type	Name	Starting	Init. Range	Minimum	Maximum
Continuous	DV_Breite_Flachsteg_oben	0	8	0	15
Continuous	DV_Breite_Flachsteg_unten	0	12	0	25
Continuous	DV_Breite_Mittelsteg_ob_au	0	6	0	13
Dependent	DV_Breite_Mittelsteg_ob_in	Definition: DV_Breite_Mittelsteg_ob_au			
Continuous	DV_Breite_Mittelsteg_un_au	0	5	0	10
Dependent	DV_Breite_Mittelsteg_un_in	Definition: DV_Breite_Mittelsteg_un_au			
Continuous	DV_Breite_Nase	0	10	0	20
Continuous	DV_Breite_Seitensteg	0	8	-5	10
Continuous	DV_Hoehe_Mittelsteg	0	8	-5	12
Continuous	DV_Hoehe_Nase	0	5	0	10

OK

Connecting ANSA to LS-OPT

Fine Tuning of Design Variables, e.g.

- Ranges
- Dependencies
- etc.

Type	Name	Starting	Init. Range	Minimum	Maximum
Continuous	DV_Breite_Flachsteg_oben	0	8	0	15
Continuous	DV_Breite_Flachsteg_unten	0	12	0	25
Continuous	DV_Breite_Mittelsteg_ob_au	0	6	0	13
Dependent	DV_Breite_Mittelsteg_ob_in	Definition: DV_Breite_Mittelsteg_ob_au			
Continuous	DV_Breite_Mittelsteg_un_au	0	5	0	10
Dependent	DV_Breite_Mittelsteg_un_in	Definition: DV_Breite_Mittelsteg_un_au			
Continuous	DV_Breite_Nase	0	10	0	20
Continuous	DV_Breite_Seitensteg	0	8	-5	10
Continuous	DV_Hoehe_Mittelsteg	0	8	-5	12
Continuous	DV_Hoehe_Nase	0	5	0	10

Connecting META to LS-OPT

Connecting META to LS-OPT

Stage for META

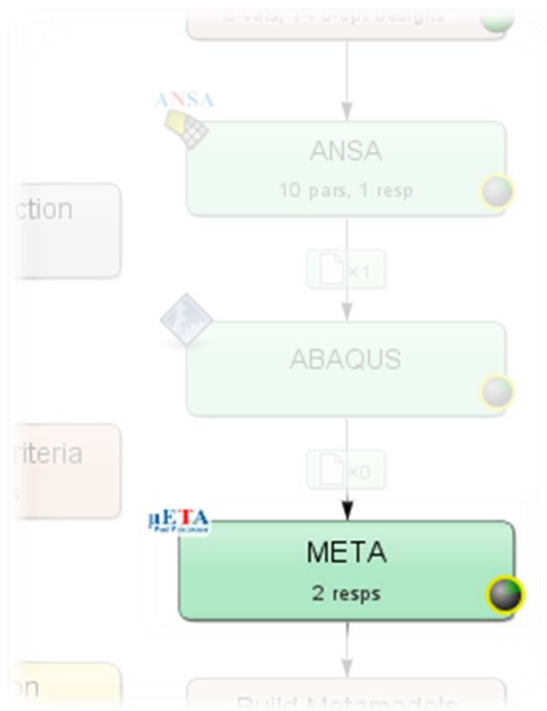

Connecting META to LS-OPT

Stage for META

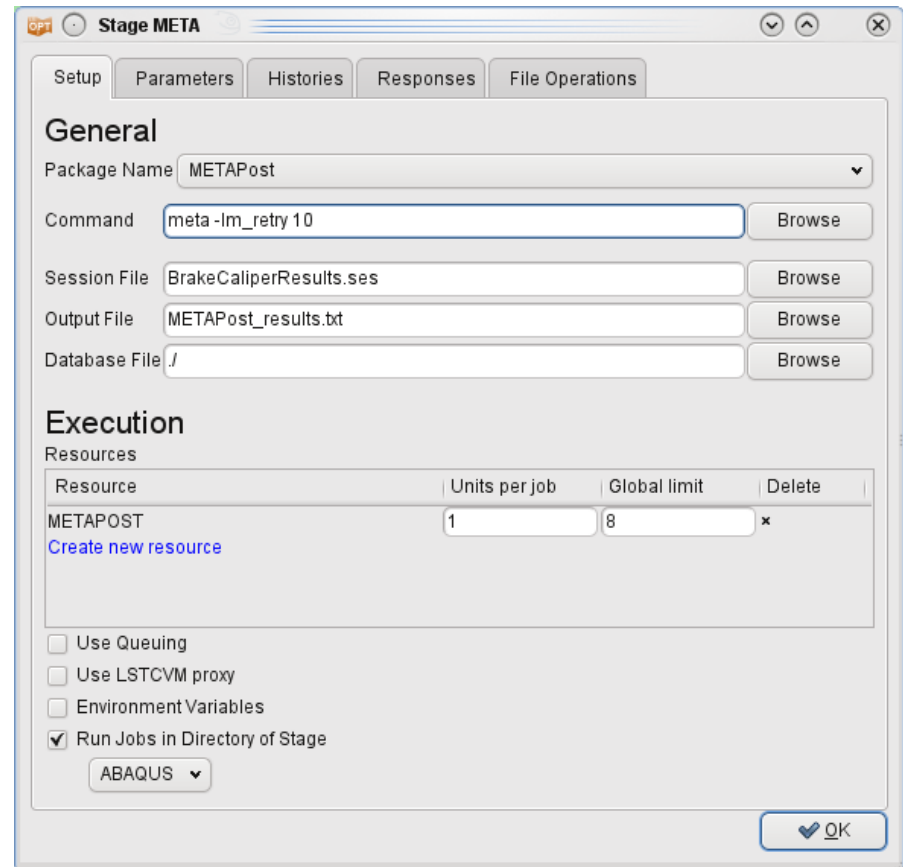
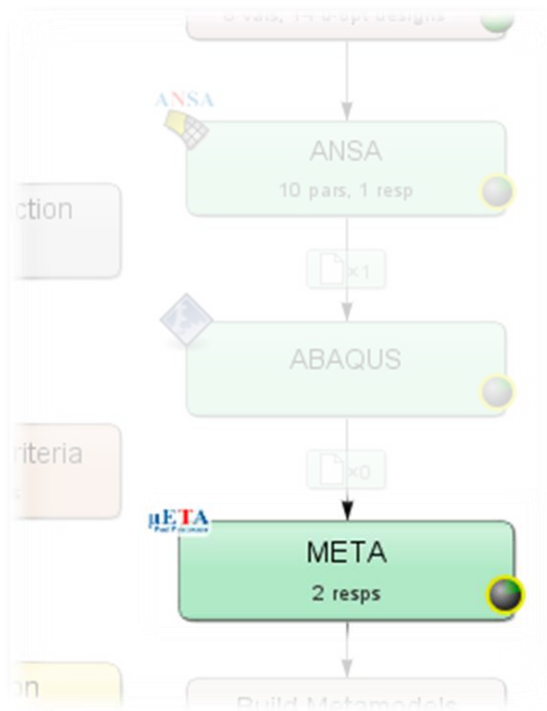

Connecting META to LS-OPT

Stage for META

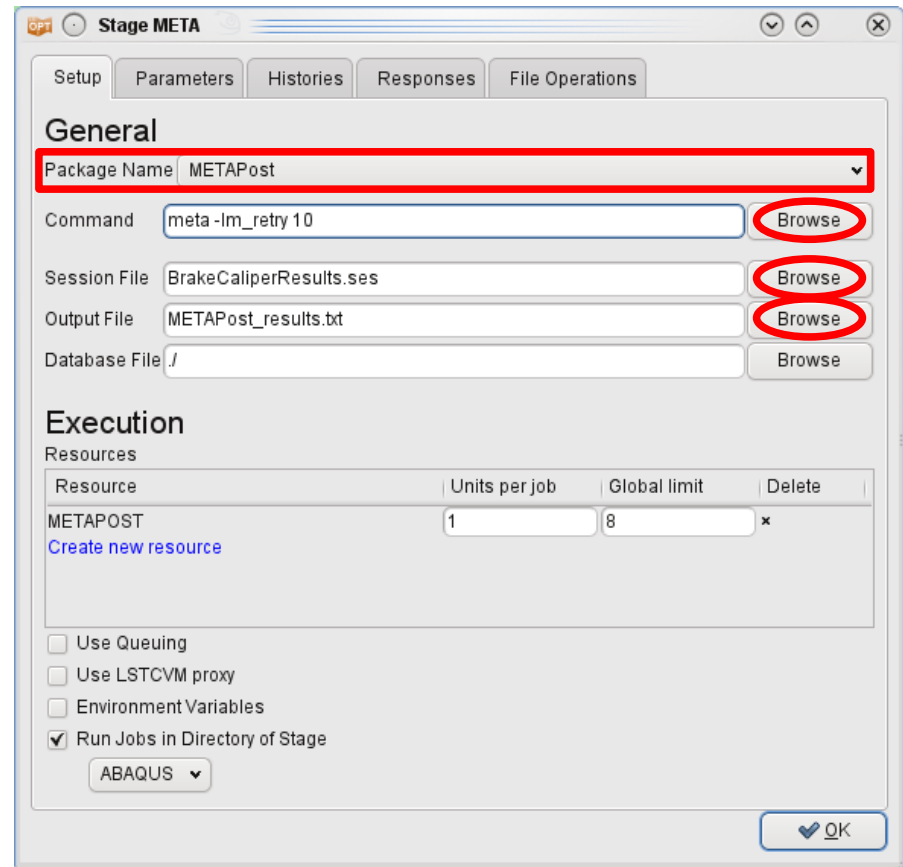
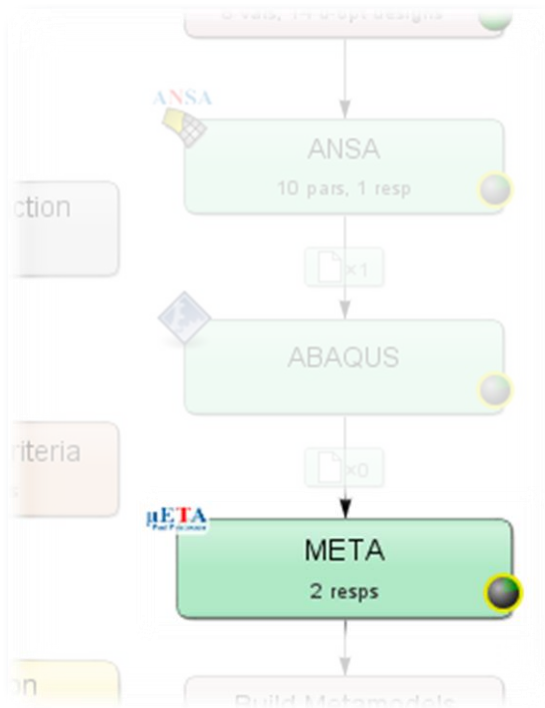

Connecting META to LS-OPT

META → Output file → Responses and Histories in LS-OPT

```
#OptimizerSetup Response & history File created by META post  
RESPONSES  
1,nodes_rel_disp,0.174171448  
2,max_stress,169.780731  
END
```

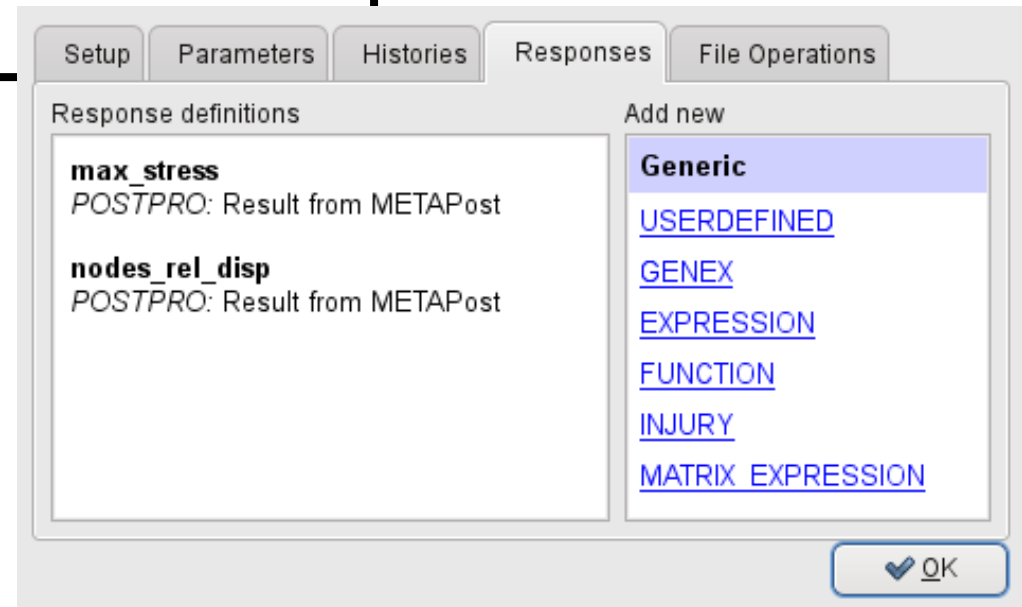

Optimization Run

LS-OPT → ANSA → Solver → META → LS-OPT

LS-OPT determines set of DV and outputs DV file

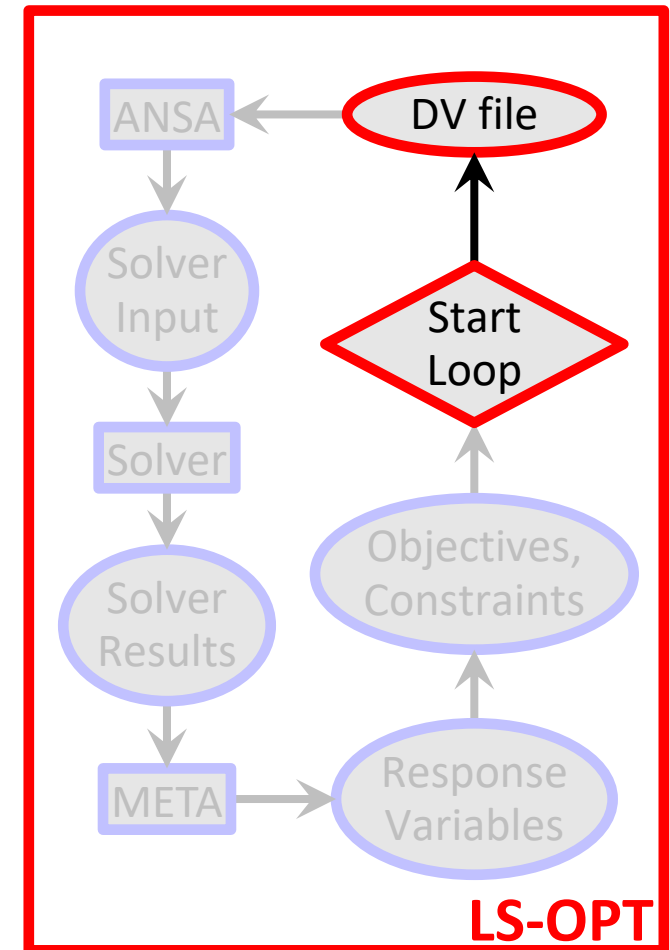

Optimization Run

LS-OPT → ANSA → Solver → META → LS-OPT

LS-OPT determines set of DV and outputs DV file

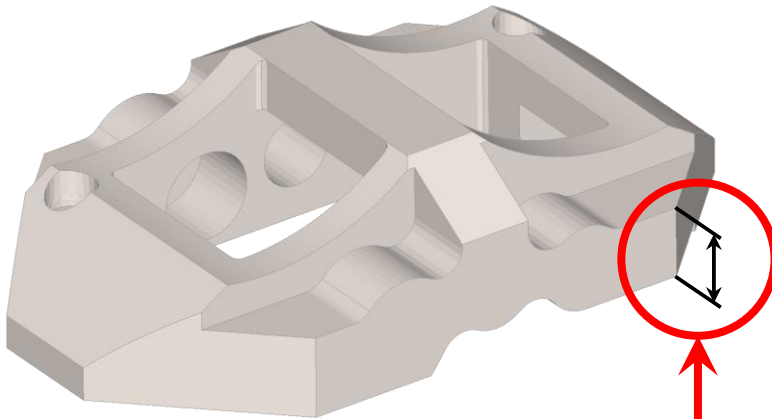

#	ID	DESIGN VARIABLE NAME	TYPE	RANGE	CURRENT VALUE	MIN VALUE
3,	DV_Hoehne_Mittelsteg,	REAL,	BOUNDS,	0., -5., 12.		
2,	DV_Breite_Seitensteg,	REAL,	BOUNDS,	0., -5., 10.		
1,	DV_Breite_Flachsteg_oben,	REAL,	BOUNDS,	0., 0., 20.		
6,	DV_Breite_Flachsteg_unten,	REAL,	BOUNDS,	0., 0., 25.		
9,	DV_Hoehne_Nase,	REAL,	BOUNDS,	0., 0., 10.		
4,	DV_Breite_Mittelsteg_ob_au,	REAL,	BOUNDS,	0., -20., 13.		
7,	DV_Breite_Mittelsteg_ob_in,	REAL,	BOUNDS,	0., -20., 13.		
5,	DV_Breite_Mittelsteg_un_au,	REAL,	BOUNDS,	0., -13., 10.		
8,	DV_Breite_Mittelsteg_un_in,	REAL,	BOUNDS,	0., -13., 10.		
10,	DV_Breite_Nase,	REAL,	BOUNDS,	0., 0., 20.		

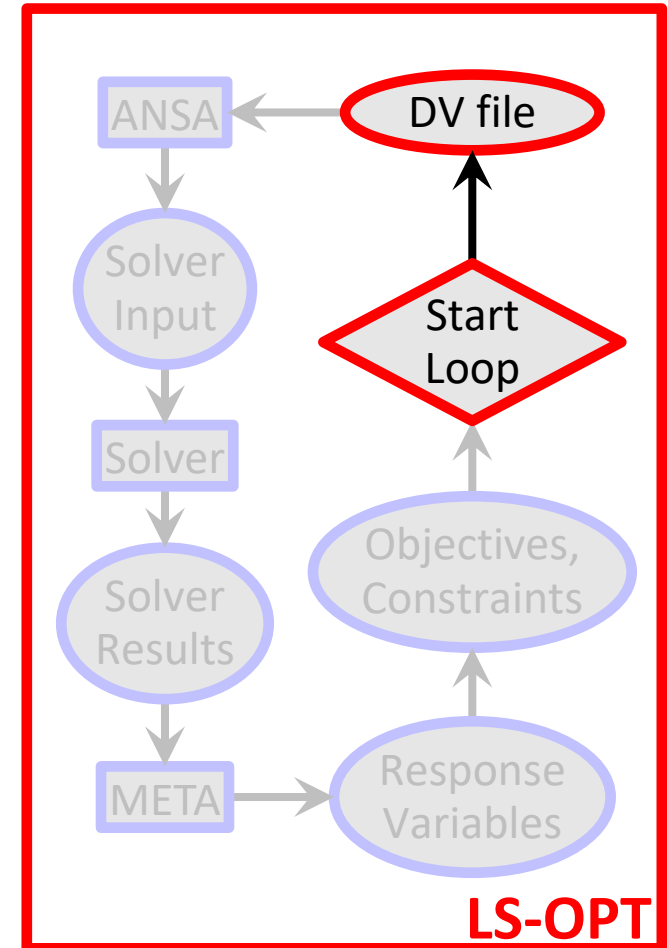

Optimization Run

LS-OPT → ANSA → Solver → META → LS-OPT

- ANSA reads DV from DV file,

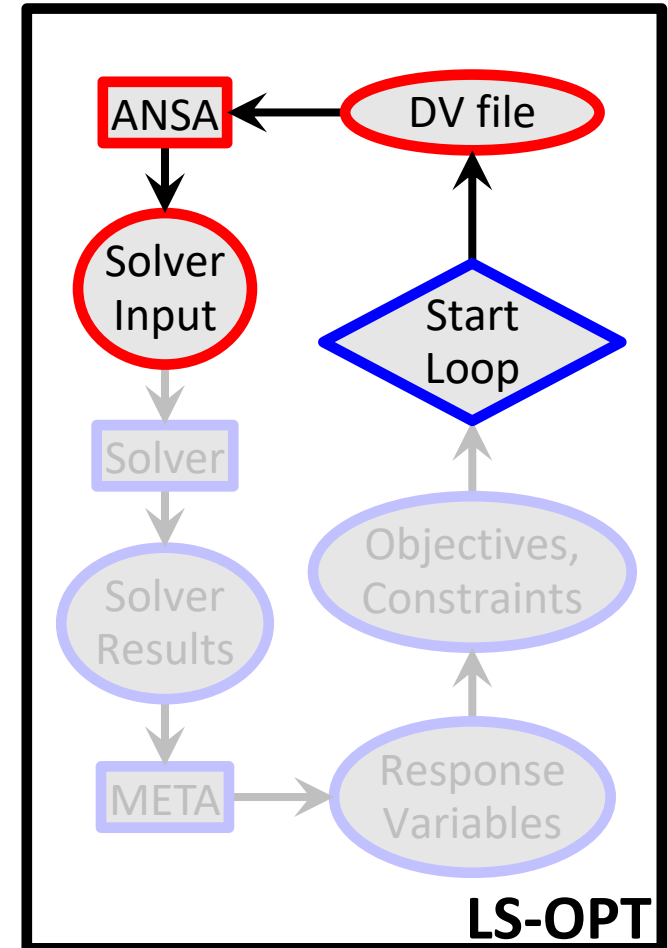

Optimization Run

LS-OPT → **ANSA** → Solver → META → LS-OPT

- ANSA reads DV from DV file,
- executes Optimization Task sequence

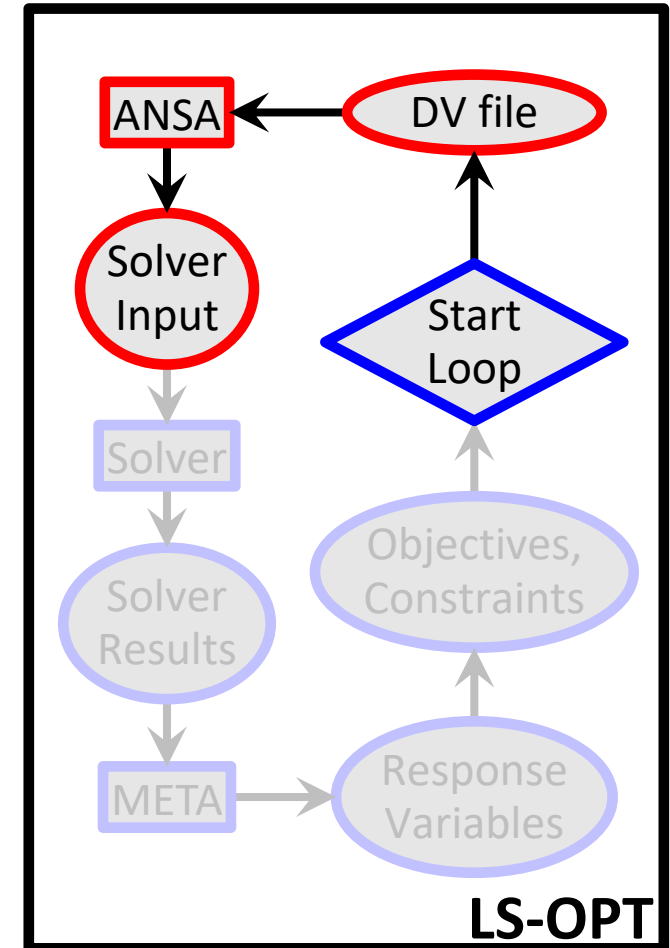
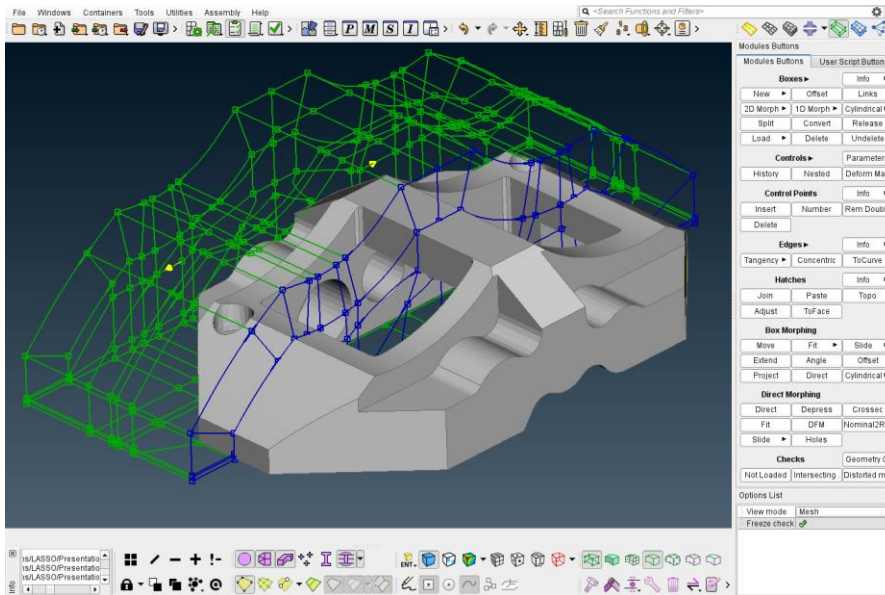

Optimization Run

LS-OPT → **ANSA** → Solver → META → LS-OPT

- ANSA reads DV from DV file,
- executes Optimization Task sequence

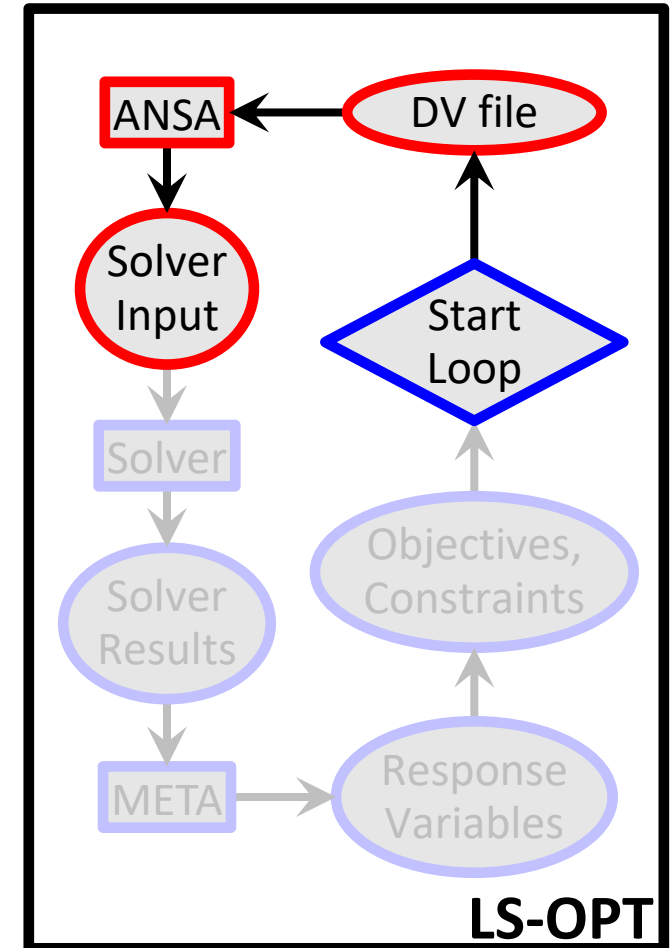
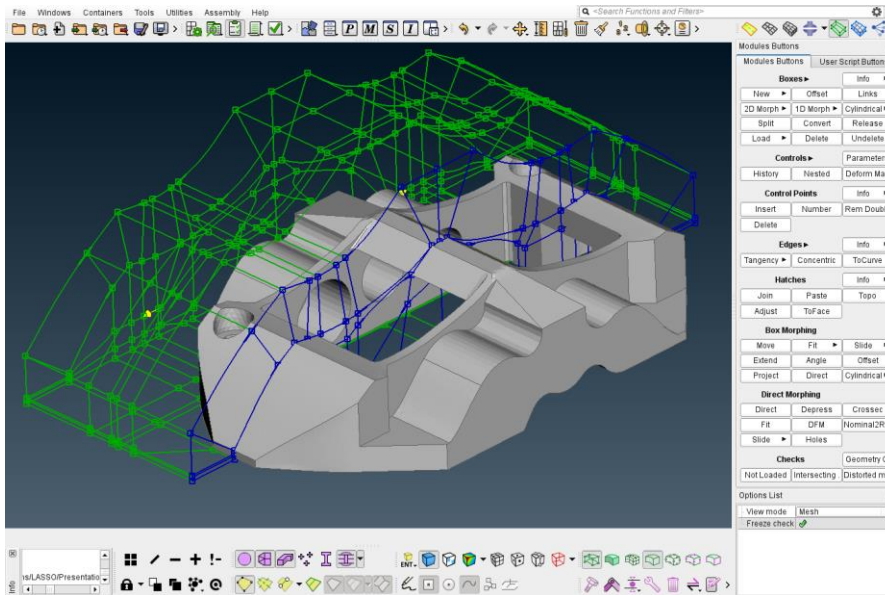

Optimization Run

LS-OPT → **ANSA** → Solver → META → LS-OPT

- ANSA reads DV from DV file,
- executes Optimization Task sequence
- and outputs solver input deck

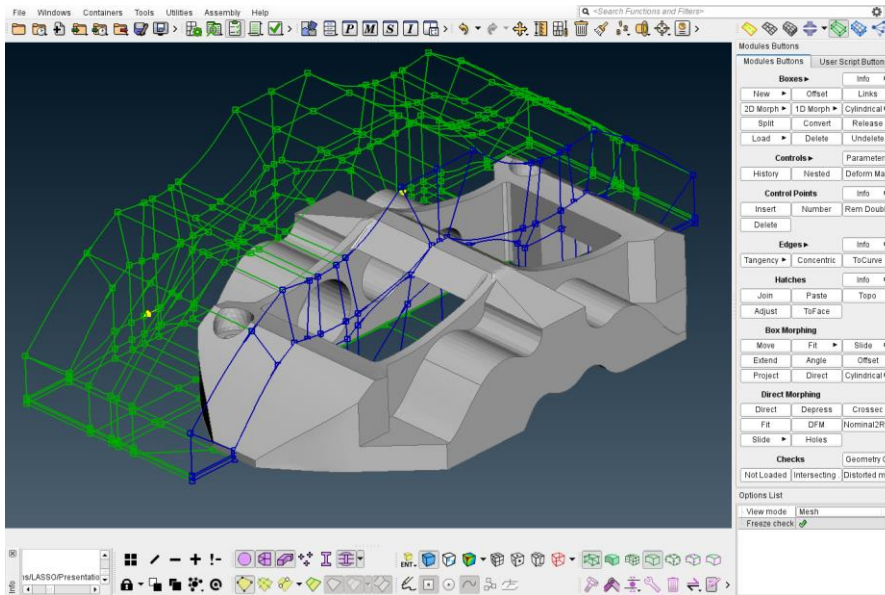

*.key / *.nas / *.inp

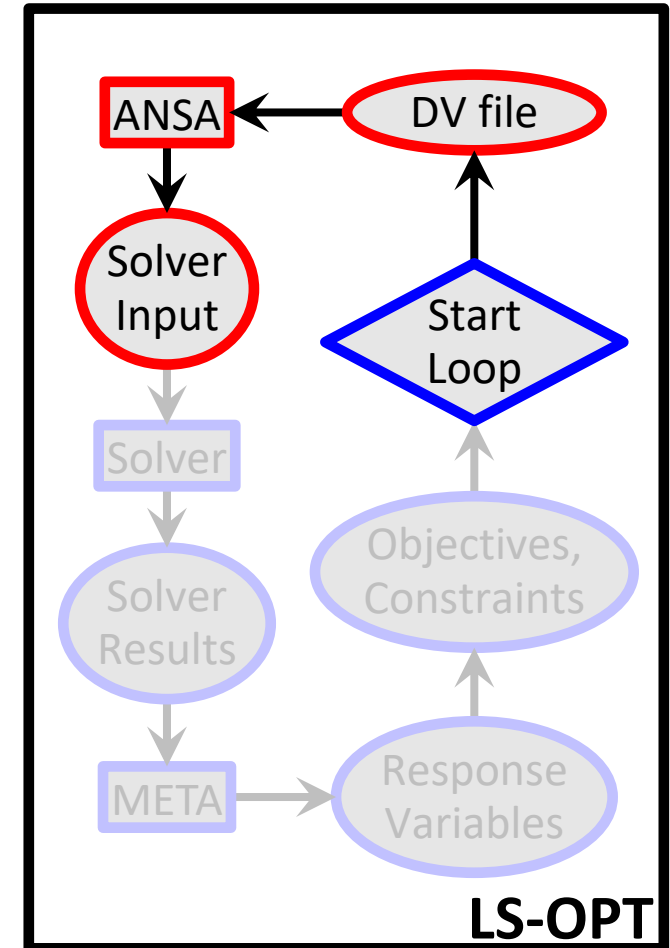

Optimization Run

LS-OPT → ANSA → **Solver** → META → LS-OPT

- LS-OPT invokes solver runs

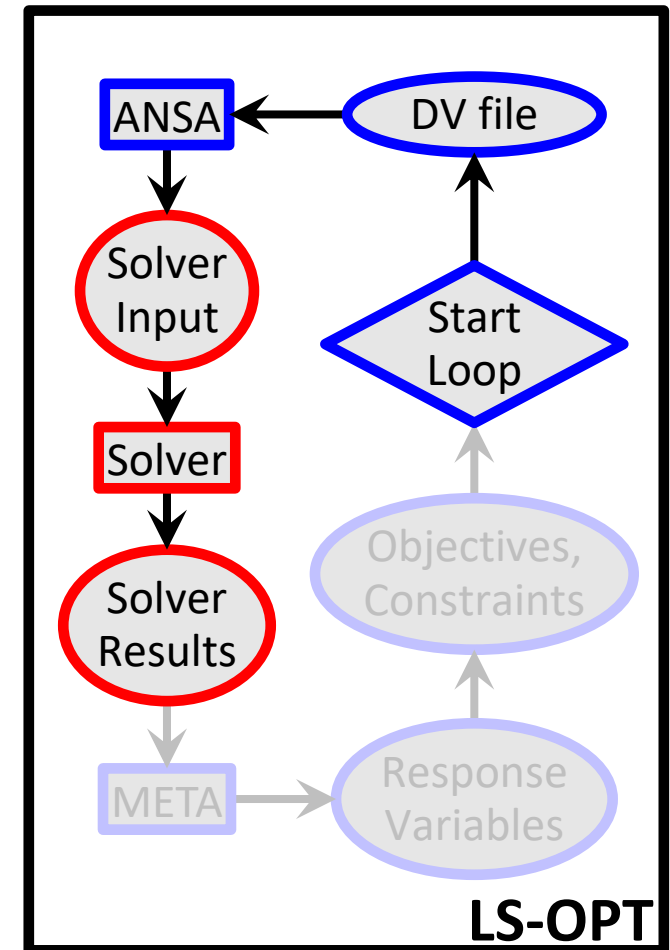
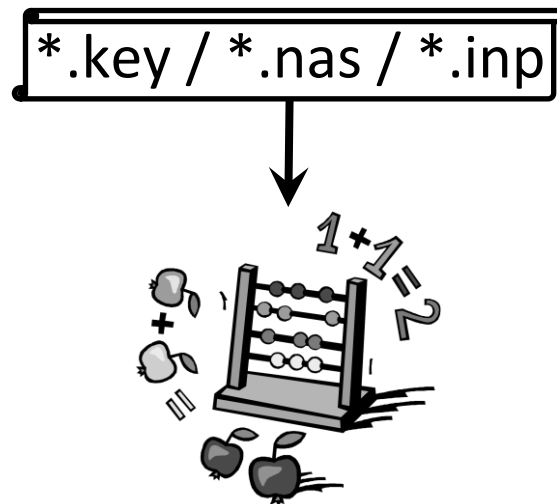

Optimization Run

LS-OPT → ANSA → **Solver** → META → LS-OPT

- LS-OPT invokes solver runs
- Solver produces result files

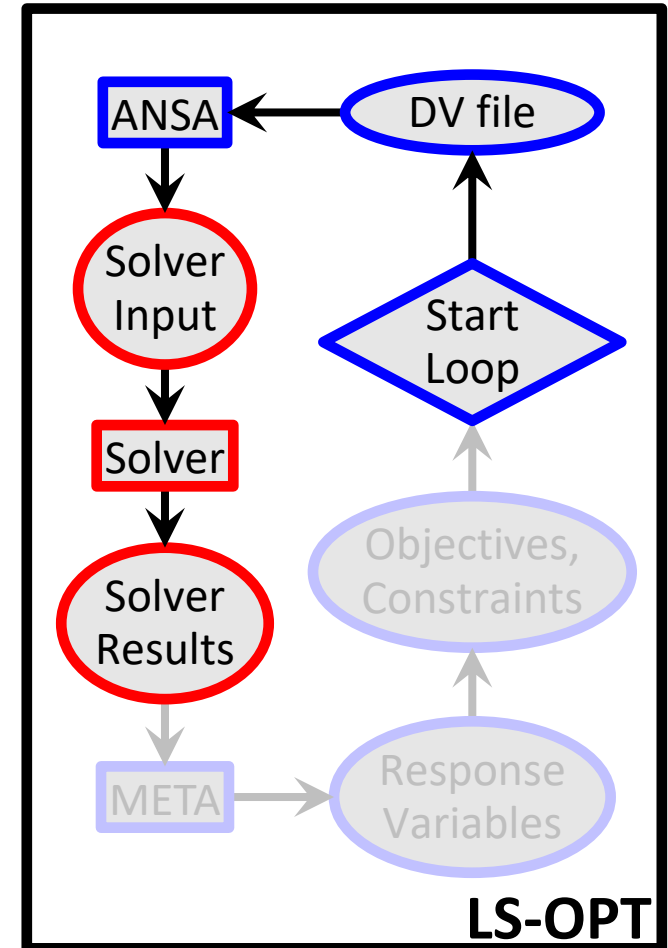
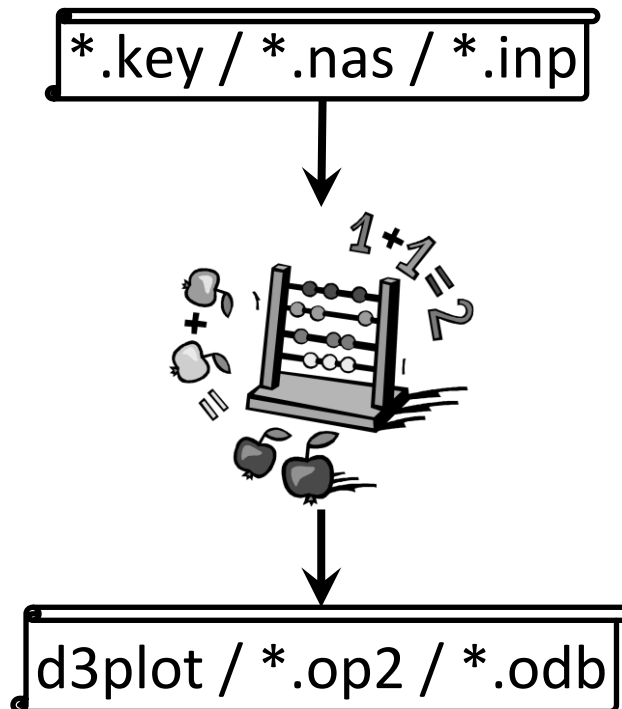

Optimization Run

LS-OPT → ANSA → Solver → **META** → LS-OPT

META extracts responses from solver result files

d3plot / *.op2 / *.odb

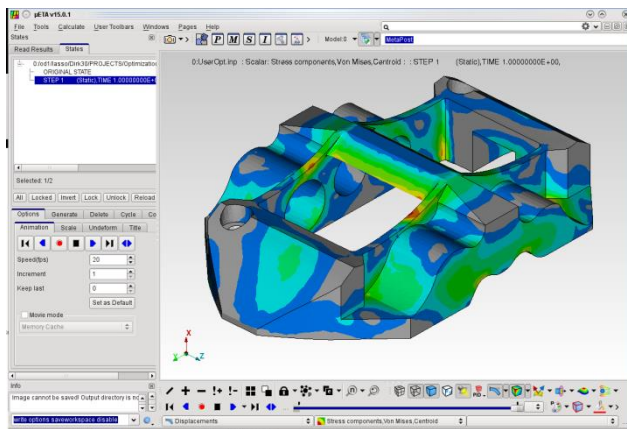

```
#OptimizerSetup Response & history File
RESPONSES
  1,nodes_rel_disp,0.174171448
  2,max_stress,169.780731
END
```

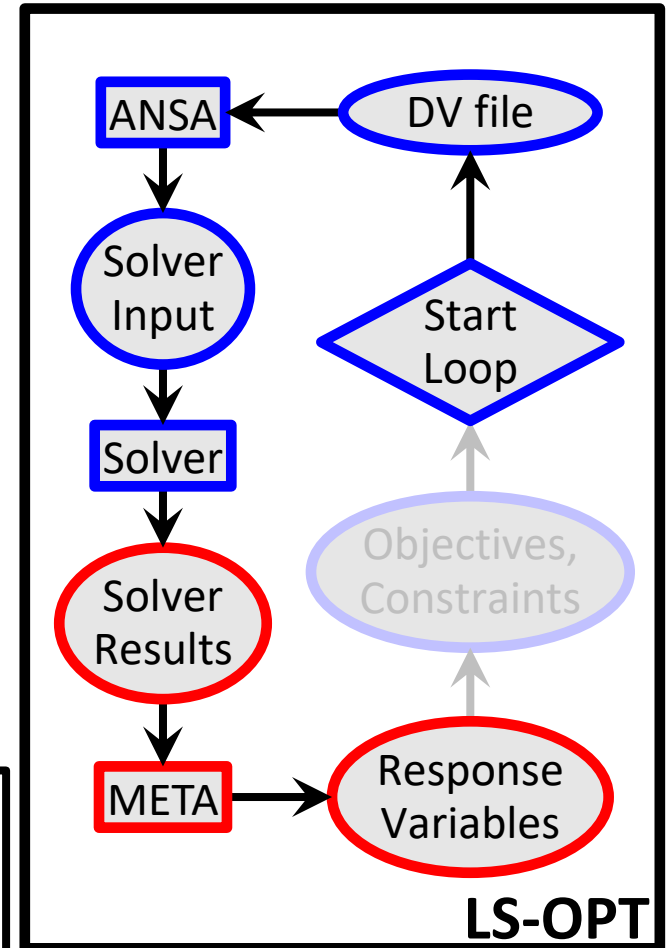

Optimization Run

LS-OPT → ANSA → Solver → META → **LS-OPT**

LS-OPT reads responses and evaluates objectives/constraints

```
#OptimizerSetup Response & history File
RESPONSES
1,nodes_rel_disp,0.174171448
2,max_stress,169.780731
END
```

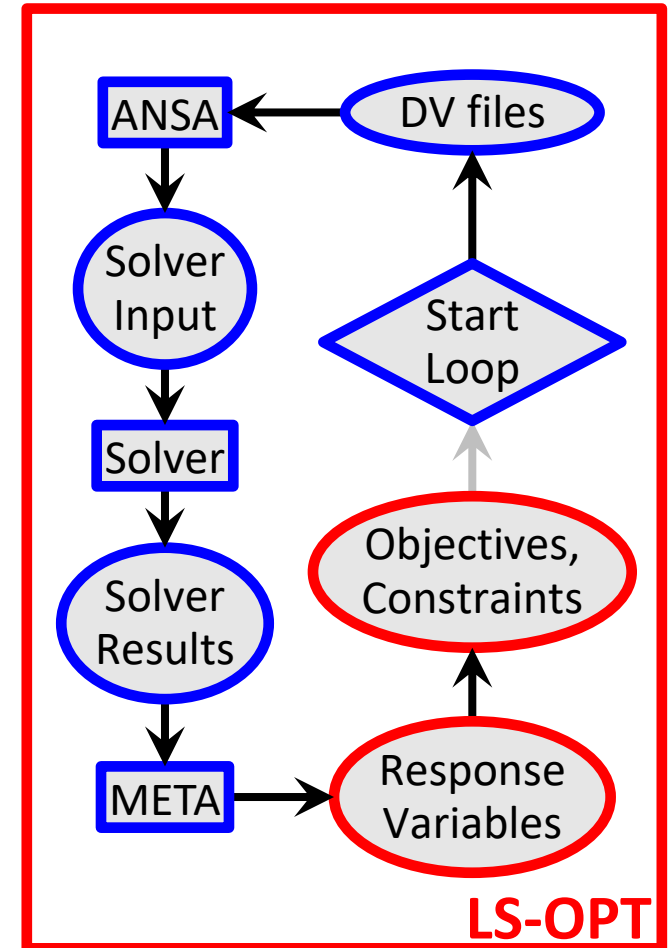
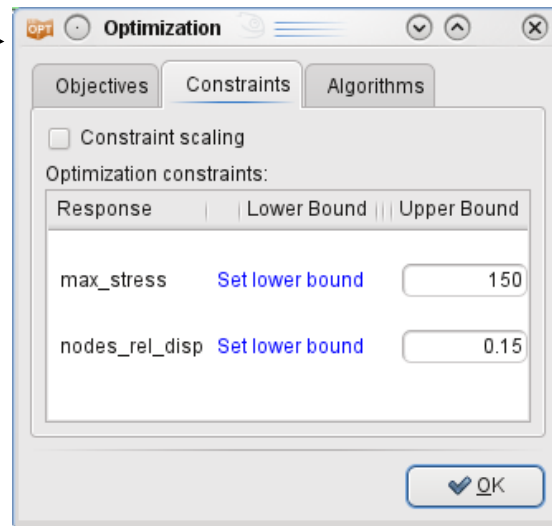

Optimization Run

LS-OPT → ANSA → Solver → META → **LS-OPT**

- LS-OPT calculates new values for DVs

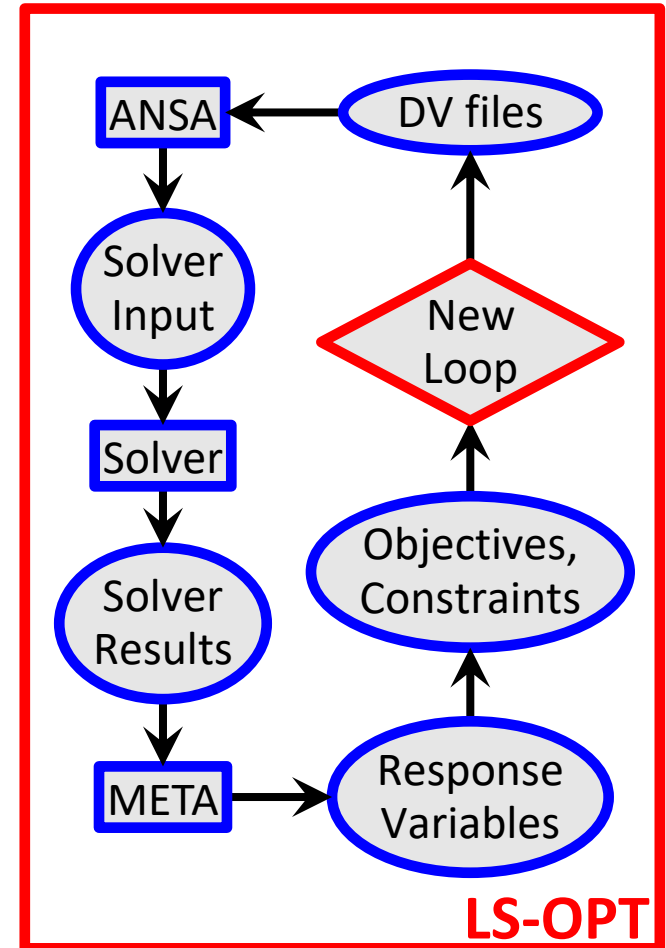

Optimization Run

LS-OPT → ANSA → Solver → META → **LS-OPT**

- LS-OPT calculates new values for DVs
- Whole process repeated until optimal solution

Initial

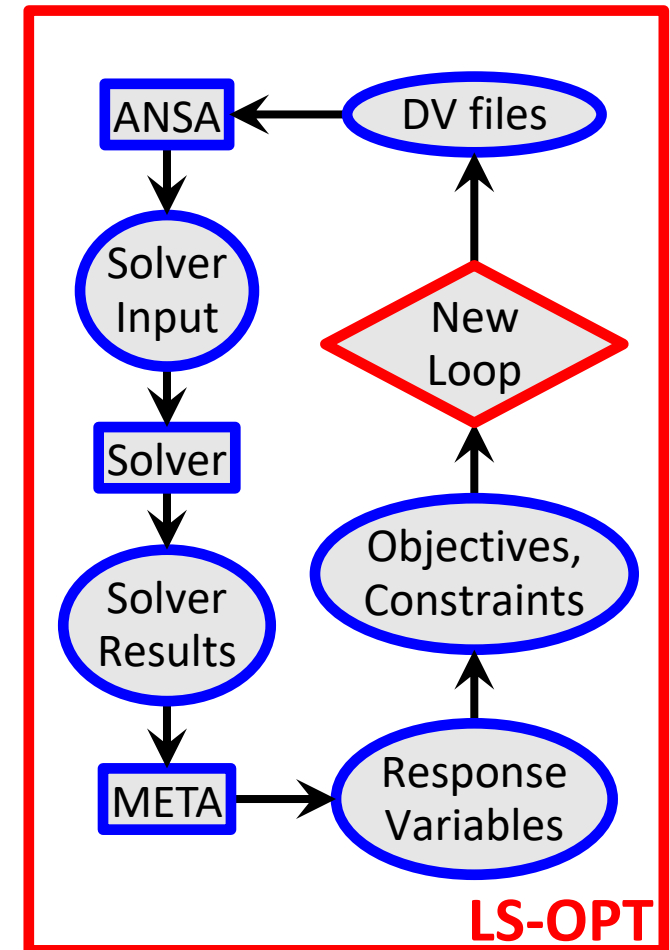
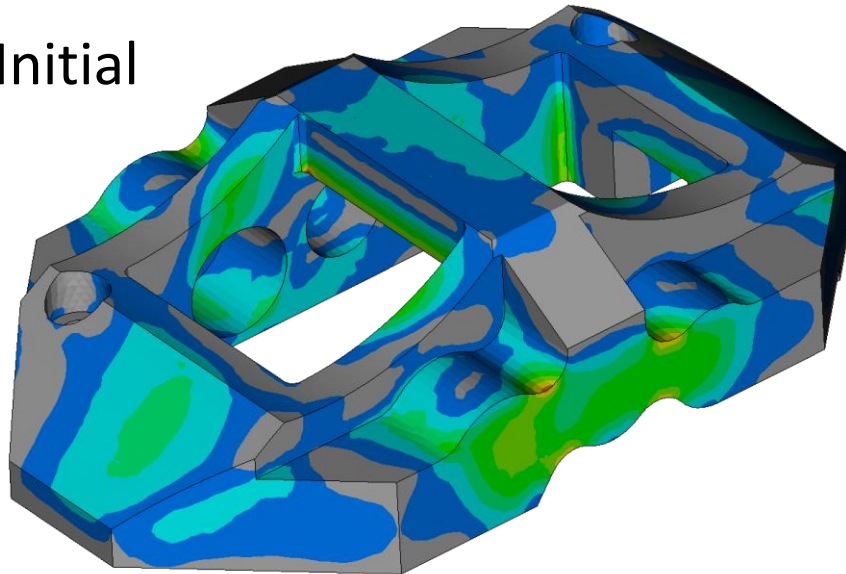

Optimization Run

LS-OPT → ANSA → Solver → META → **LS-OPT**

- LS-OPT calculates new values for DVs
- Whole process repeated until optimal solution

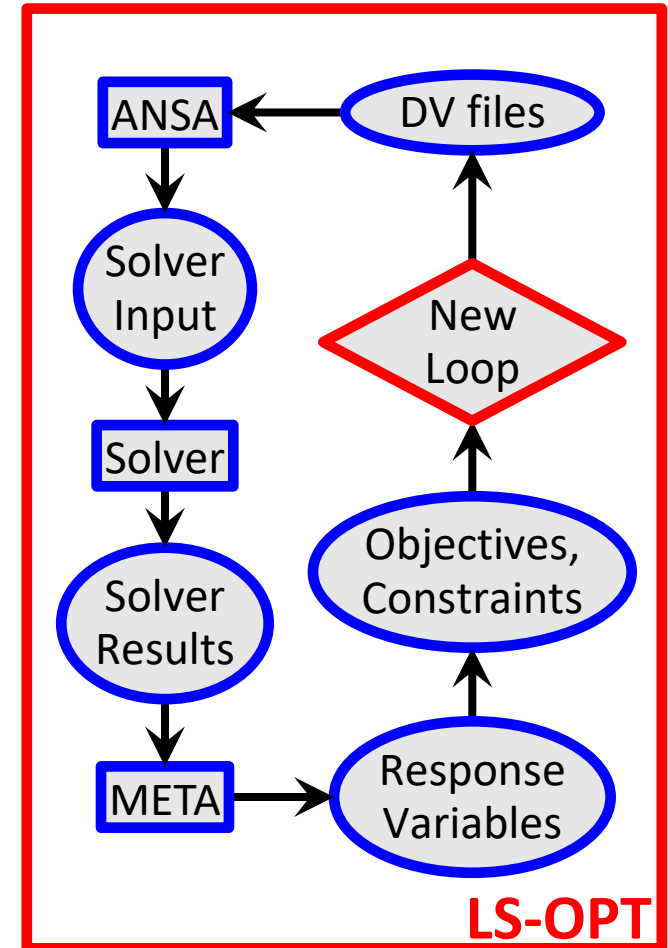
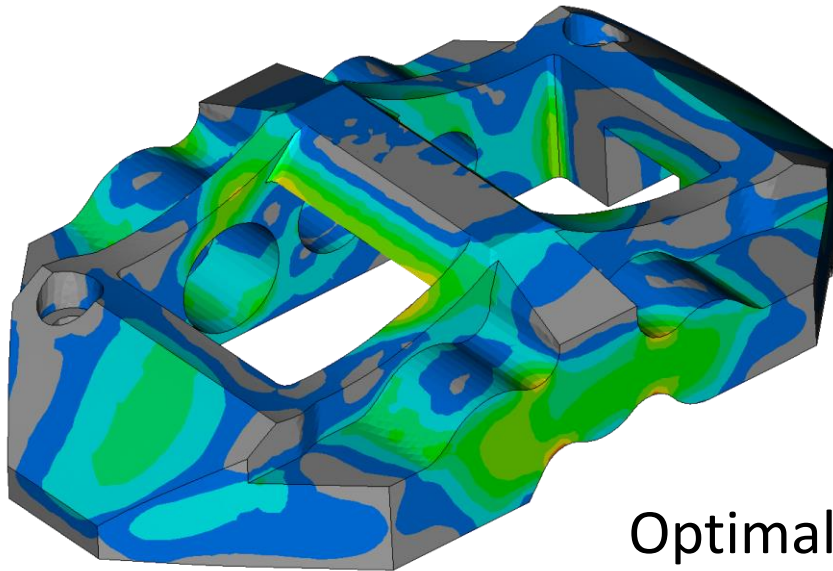

Ευχαριστώ πολύ

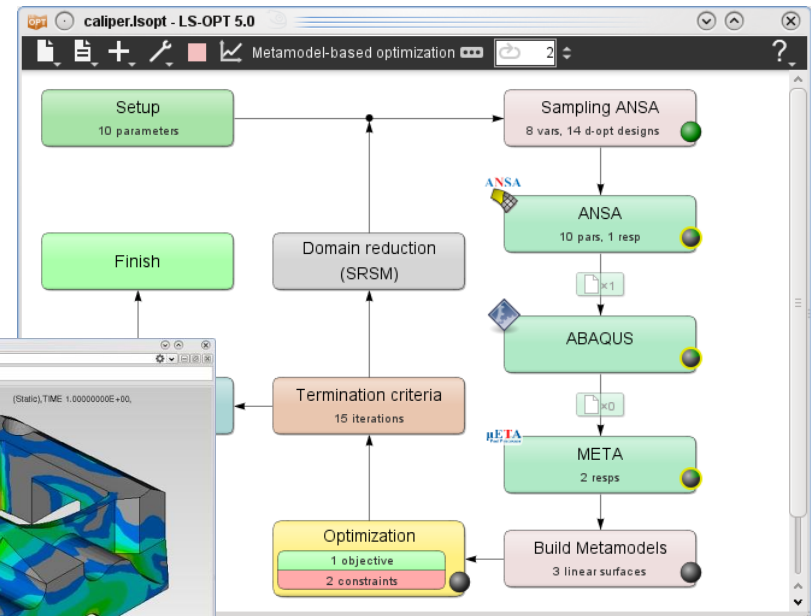
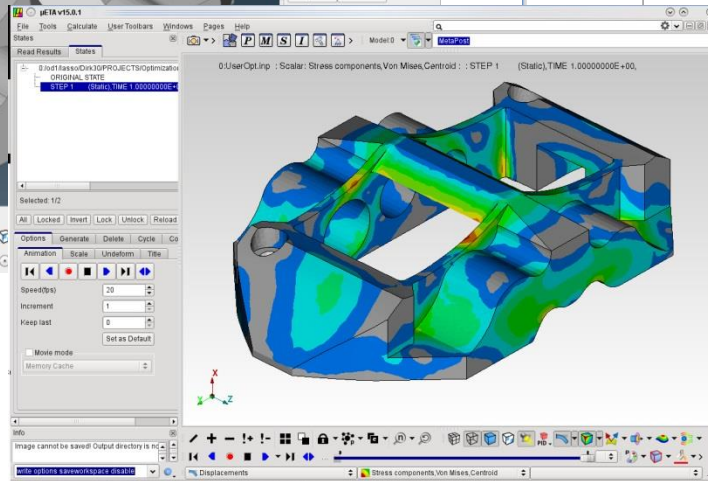
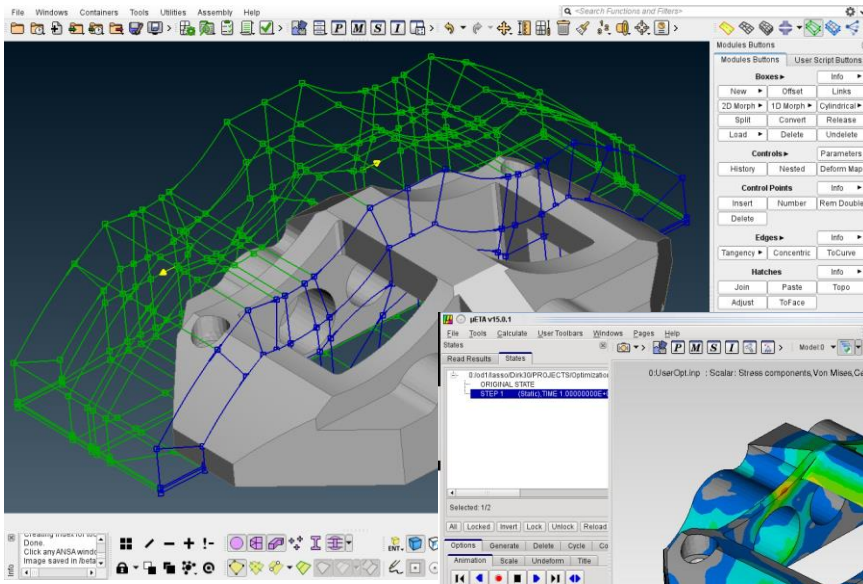

Ευχαριστώ πολύ

More information and examples on
www.isoptsupport.com

Mail: ansa@lasso.de

